

Habitat Conservation Plan for the Town of Gander

**Prepared with assistance from the
Department of Environment and Conservation
Wildlife Division
2013**

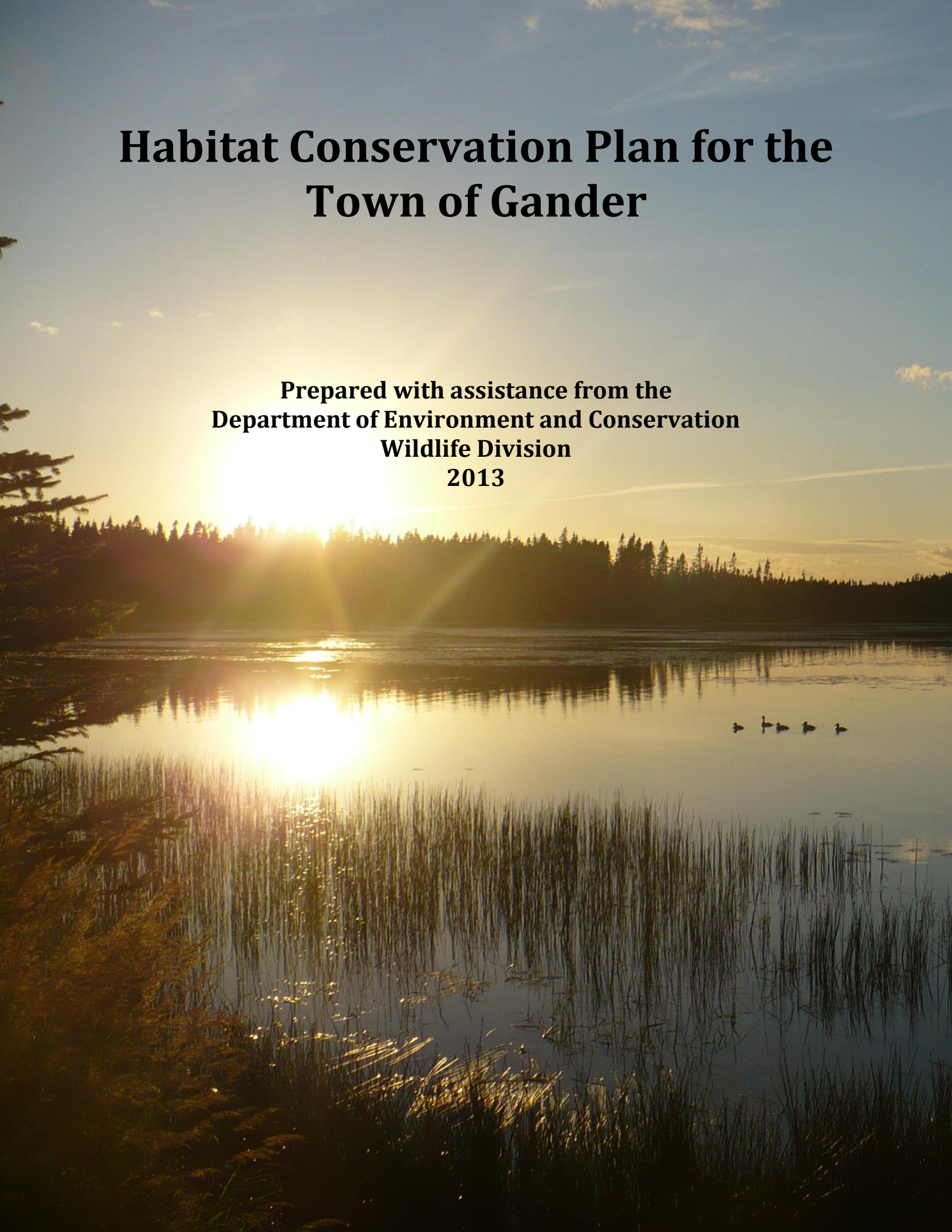

Habitat Conservation Plan for the Town of Gander

June 2013

**Prepared with assistance from the
Department of Environment and Conservation- Wildlife Division**

**Town of Gander
100 Elizabeth Drive
Gander, NL
A1V 1G7
(709) 651-2930
info@gandercanada.com**

**NL Eastern Habitat Joint Venture
Department of Environment and Conservation - Wildlife Division
117 Riverside Drive, P.O. Box 2007
Corner Brook, NL
A2H 7S1
(709) 637-2006**

PREFACE

In Newfoundland and Labrador, some of the waterfowl and wildlife that are in greatest danger of being negatively impacted are those influenced by residential, commercial and industrial activities within the vicinity of municipalities. In this province, the primary focus of the Eastern Habitat Joint Venture is to conserve valuable wildlife habitat through Stewardship Agreements. The Town of Gander was identified as having just such ecologically valuable, and unique, wetland habitat located within its municipal boundaries.

The Town of Gander first signed an agreement on June 22, 1993, pledging their commitment to conservation and protection of wetlands within a specified Stewardship Zone and, particularly, within two Management Units: Cobb's Pond and Northwest Bog. Since that time, the Town of Gander has further amended its Stewardship Agreement on two occasions. On Sept 10, 1997, the Town expanded the scope of its Management Units to include a wetland constructed in Benton for waste water treatment. Again on March 14, 2007, the Town of Gander further expanded its Stewardship Agreement to include Peyton's Pond and Whitman's Pond as additional Management Units due to their high importance for waterfowl nesting and brood-raising. In accordance with this agreement, Gander manages these wetland areas with technical advice provided by the provincial Wildlife Division, in part via a Habitat Conservation Plan. Gander's original plan, signed in 1995, has been updated herein. With the signing of this plan, the agreement parties officially accept this updated Habitat Conservation Plan and agree to use it as a guide to govern activities within the designated Stewardship Zone and Management Units.

The following signatories agree to work towards the implementation of the following "Habitat Conservation Plan" for the Town of Gander:



Mayor



TOWN CLERK

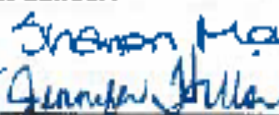

Witness



Date



Date



Date



Wildlife Division
Department of Environment and Conservation



Date

TABLE OF CONTENTS

	Page
Section 1: Plan Overview.....	1
Plan Purpose	
Plan Goals	
Plan Objectives	
Section 2: Wetland Conservation in Newfoundland and Labrador.....	2
Introduction	
Eastern Habitat Joint Venture (EHJV)	
NL EHJV Wetland Stewardship Program	
The Stewardship Agreement Process	
Roles of Stewardship Agreement Signatories	
Section 3: Wetlands and Waterfowl in the Town of Gander.....	6
The Town of Gander	
Description of the Stewardship Zone	
Description of the Management Units	
Section 4: General Policies for Wetland Conservation.....	23
The Town's Commitment to Stewardship	
Benefits for Residents	
Management of the Stewardship Zone	
Management of the Management Units	
Incorporation of Management Units in Municipal Plans	
Riparian Buffers in the Management Units	
Management by Committee	
Stewardship Association of Municipalities Inc. (SAM)	
Section 5: Wetland Conservation and Education Strategies.....	27
Waterfowl Monitoring Project	
Conservation Corps Green Teams	
Artificial Nesting and Loafing Structures	
Educational Programs	
Habitat Enhancement	

LIST OF FIGURES

	Page
Figure 1: Map of the Northwest Bog Management Unit.....	8
Figure 2: Aerial Photo of the Northwest Bog Management Unit.....	9
Figure 3: A portion of the Northwest Bog Management Unit.....	9
Figure 4: Map of the Cobb's Pond Management Unit.....	11
Figure 5: Aerial Photo of the Cobb's Pond Management Unit.....	12
Figure 6: Nesting Common Loon in Cobb's Pond.....	12
Figure 7: Brood of American Black Ducks in Cobb's Pond.....	13
Figure 8: Brood of Green-winged Teal in Cobb's Pond.....	13
Figure 9: Map of the Benton (Constructed Wetland) Management Unit.....	14
Figure 10: Aerial Photo of the Benton (Constructed Wetland) Management Unit.....	15
Figure 11: Benton's (Constructed Wetland) Management Unit.....	15
Figure 12: Map of the Whitman's Pond Management Unit.....	17
Figure 13: Aerial Photo of the Whitman's Pond Management Unit.....	18
Figure 14: Looking North at Whitman's Pond Management Unit.....	18
Figure 15: Map of Peyton's Pond Management Unit.....	20
Figure 16: Aerial Photo of Peyton's Pond Management Unit.....	21
Figure 17: Peyton's Pond Management Unit.....	22
Figure 18: American Black Duck's in Peyton's Pond.....	22
Figure 19: Osprey Nesting Platform in Stephenville Crossing.....	29
Figure 20: Cavity Nest Box in Cobb's Pond.....	30
Figure 21: Bat Roosting Box in Salmonier Nature Park.....	33
Figure 22: Fish Baffles in Grand Falls – Windsor.....	37

LIST OF APPENDICES

	Page
Appendix 1: Municipal Stewardship Agreement.....	39
Appendix 2: Map of Gander’s Management Units.....	42
Appendix 3: Waterfowl Monitoring Project Protocols and Data Sheet.....	43
Appendix 4: Wildlife Species Found in the Gander Stewardship Zone.....	48
Appendix 5: Trail Entrance Interpretative Sign, Steady Brook.....	50
Appendix 6: Artificial Nesting and Loafing Structures.....	51
Appendix 7: Shoreline Planting Chart.....	61
Appendix 8: Bird-watching (Viewing) Tower.....	64
Appendix 9: Bird Blinds.....	65
Appendix 10: Viewing Deck.....	66
Appendix 11: Appropriate Wording for a Potential “No-Shooting” Sign.....	67

Section 1: Plan Overview

Plan Purpose: The Town of Gander will use this Conservation Plan as a guide to govern activities which impact wetlands and waterfowl in order to minimize negative impacts within the areas designated for conservation.

Plan Goals:

- (1) To conserve wetlands located within the designated Management Units.
- (2) To maintain and/or increase wildlife use of the Management Units, particularly by waterfowl and other avian species.
- (3) To increase public awareness of the importance of wetland habitats for conserving waterfowl and other wildlife.

Plan Objectives:

- (1) To present a general assessment of the wetland habitats and waterfowl or wildlife species designated for protection.
- (2) To recommend protection, conservation and enhancement strategies for the Management Units.
- (3) To describe potential initiatives for education and awareness among the public in order to increase support and cooperation of the Town's citizens.

Section 2: Wetland Conservation in Newfoundland and Labrador

Introduction

Human development has resulted in the destruction of many types of habitat all over the world. Wetlands are among the areas most critically affected by this development and are, in fact, one of the most sensitive ecosystems on the planet. Wetlands are unique ecosystems that often occur at the edge of aquatic (water, fresh or salty) or terrestrial (upland) systems. They may be wet year-round, wet during certain seasons, or wet during part of the day. In general, “wetland” refers to land that has the water table at, near, or above the land’s surface and refers to land which is saturated for a long enough period to promote wetland processes. In addition to bogs and swamps, wetlands include tidal marshes, forested wetlands, fens, estuaries and shallow open water (at a depth less than two meters). Healthy wetlands and associated uplands contain fresh, brackish or salt water and are some of the most biologically diverse and productive ecosystems on earth.

Wetlands play a major role in the status of continental ecosystem health, as well as regional and local ecosystem health. Wetlands serve as important buffers to flooding, function as enormous sinks for carbon and as natural reservoirs for the holding, purifying and recharging of water resources. From an economic stance, wetlands are associated with a range of values from recreational and subsistence opportunities for hunting, fishing, trapping for food and fur, the gathering of fruit and berries and for non-extractive activities like wildlife viewing, ecotourism, paddling sports and hiking. Wetlands also provide for the seasonal resource requirements of many waterfowl species and serve as important habitat for waterfowl throughout breeding, feeding, staging and over-wintering. All migratory waterfowl, many other migratory birds, and half of all threatened and endangered species depend on wetlands and associated upland habitat for their existence.

The number and diversity of North America’s wildlife species has been declining over the latter half of the twentieth century. At least a portion of this decline can be directly attributed to the loss of natural habitats to urban, industrial and agricultural expansion. Wetlands have historically been among those areas most critically impacted by human development. Canada, the United States and Mexico have signed the North American Waterfowl Management Plan (NAWMP), thereby committing to a long-term program of partnership projects aimed at assuring the survival and increase of waterfowl populations and protecting the wetland habitat on which their survival depends. A number of joint ventures, ranging from species to regional-specificity, have been established to achieve and implement the objectives of the NAWMP. The province of Newfoundland and Labrador, through the provincial Wildlife Division, became a partner of the Eastern Habitat Joint Venture (EHJV) in 1989.

Eastern Habitat Joint Venture (EHJV)

The premise behind the EHJV is to conserve, enhance and restore wildlife habitat for all-bird species, in particular wetlands for waterfowl, in the six eastern Canadian provinces including Ontario, Quebec, New Brunswick, Nova Scotia, Prince Edward Island and Newfoundland and Labrador. Each province deals with wildlife habitat conservation issues slightly differently, depending on the unique requirements of each province and individual habitat concerns. Each provincial program, coordinated by a separate program manager, involves the cooperation of international partners, including government agencies and non-government groups, each working to forward specific goals and objectives of the NAWMP. In Newfoundland and Labrador, the program is administered through the provincial Wildlife Division of the Department of Environment and Conservation. Its local contributors, other than the province, include Ducks Unlimited Canada, Canadian Wildlife Service, Nature Conservancy of Canada and Wildlife Habitat Canada. While each province may function independently, the EHJV works towards attaining common goals of influencing wildlife habitat quality and quantity in Eastern Canada through conservation, enhancement and/or restoration initiatives.

NL EHJV Wetland Stewardship Program

Wetlands have historically been affected by heavy development pressure. In Newfoundland and Labrador development pressure occurs regularly and most often within municipal boundaries. As such, wetlands that exist within municipal boundaries are often at the greatest risk of destruction or alteration and often in greatest need of conservation and/or management. Municipal Wetland Stewardship is perhaps the most successful component of the Eastern Habitat Joint Venture in Newfoundland and Labrador. Its principle goal is to help make municipalities, corporations, developers, landowners, and other wetland habitat stakeholders more aware of the value of wetlands within their jurisdiction and to empower them to take action to conserve these areas. This leads to more informed development decision-making and works towards minimizing negative impacts on wetland areas and local ecosystems as a whole.

This component of the program focuses largely upon signing Stewardship Agreements with municipalities, corporations and individual landowners who own or manage significant wetland habitat. A Stewardship Agreement represents a formal public commitment by a community, corporation, individual and the province, to act together to conserve wetlands for waterfowl. By signing a Stewardship Agreement, communities, corporations and individuals become an important link in a continental chain of conservation areas. Nearly 40 municipalities have signed Municipal Stewardship Agreements. Corporate Stewardship Agreements have also been signed by the Iron Ore Company of Canada and Corner Brook Pulp and Paper Limited. Private landowners in several of the communities surrounding the Grand Codroy Estuary (an estuary of international significance) as well as Burgeo have also been involved with the signing of Landowner "Good

Steward” Agreements, demonstrating individual commitment to local wetlands and waterfowl habitat.

The Stewardship Agreement Process

Initial contacts are generally sought by both Wildlife Division staff and local community leaders who wish to take action to conserve coastal, wetland and/or upland habitat. A determination is made between the parties of whether there exists mutual interest in pursuing a Stewardship Agreement (Agreement shown in Appendix 1). Surveys within a certain area of interest are carried out by the Wildlife Division to confirm that a significant relationship exists between coastal, wetland or upland habitat and local wildlife using those areas.

Following these positive assessments, more intensive field investigations will be carried out to determine and agree on formal boundaries for “Management Units” and “Stewardship Zones”. Management Units are significant habitat areas that have been identified as important to wildlife. Management Units are intended to be incorporated as environmentally “sensitive areas”, “conservation areas” or “protected areas” within municipal planning documents as governed by the Urban and Rural Planning Act (2000). These areas are, consequently, set aside by a community, individual or corporation in an effort to prevent habitat alteration and diminished ecological function or degradation that might be caused by development.

When sufficient information has been gathered, a preliminary proposal is presented to a community, individual or corporation for review, with suggested boundaries for Management Units clearly indicated (Map found in Appendix 2). After the Management Units have been agreed upon by all parties, a formal Stewardship Agreement will be signed between the presiding body (town, corporation, or landowner) and the province. Under this agreement, the town, corporation or landowner maintains ultimate control over all areas under its jurisdiction, but are asked to abide by the details of the Stewardship Agreement.

After the signing of a formal agreement, Wildlife Division staff will assist the community, corporation or individual in preparing an area specific Habitat Conservation Plan. This plan will serve to offer best management practices and will provide recommendations and advice for conserving, enhancing and/or managing the wildlife habitat contained within a body’s area of authority. In the case of a municipal agreement, once the Habitat Conservation Plan has been accepted by council it is intended that it will be then incorporated into the town’s existing or future municipal plan, operating plan or master plan for use during future development decisions. More generally, a Stewardship Agreement is signed with the idea that when land use decisions are made, the value of wildlife habitat will not be forgotten and that future land-use activities will not have a negative impact upon these values.

Roles of Stewardship Agreement Signatories

“The Province” - The Minister of Environment and Conservation is generally the designated signatory on behalf of the province. The Wildlife Division administers the Eastern Habitat Joint Venture in Newfoundland and Labrador. As such, staff of the Wildlife Division are assigned to implement, on a provincial basis, the NL EHJV Stewardship program.

As a result of signing a Stewardship Agreement, staff of the Wildlife Division are expected to:

- Provide the agreement signatory with technical advice and assist in the development of a Habitat Conservation Plan.
- Review proposed developments within the Management Units that have the potential to impact that wildlife habitat.
- Assist in carrying out, where appropriate, education and information initiatives to raise awareness of wildlife, wetland and coastal related issues, and
- Support community conservation groups in implementing the Stewardship Agreement and Habitat Conservation Plan.

As a result of signing a Municipal Habitat Stewardship Agreement, the Municipality and its designated Mayor/Council are expected to:

- Ensure that significant wildlife habitat areas designated as Management Units are protected from destruction or degradation and to contact the Wildlife Division in a timely manner when activities are proposed that may impact that habitat.
- Incorporate the Stewardship Agreement and Habitat Conservation Plan into its next Municipal Plan draft or revision with the assistance of the Wildlife Division.
- Educate residents and development planners about the stewardship program and their responsibilities, with the assistance of the EHJV partners.
- Implement, over time, the Habitat Conservation Plan recommendations in the community at large, with the assistance of the EHJV partners.
- Participate in the Stewardship Association of Municipalities Inc (SAM), a province-wide organization made up of municipalities which have signed Stewardship Agreements.

Section 3: Wetlands and Waterfowl in the Town of Gander

The Town of Gander

The Town of Gander is situated in central Newfoundland on the northeastern shore of Gander Lake at the junction of the Trans Canada Highway and the Gander Bay Road (Route 330). The municipality is the site of Gander International Airport, formerly an important refueling point for transatlantic aircraft, and, to this day, a preferred stopping point for transatlantic aircraft that need to land because of on-board medical or security emergencies. The town serves as a regional service centre for some 80,000 people in more than 300 neighboring communities.

Gander's Municipal Boundary encompasses an area of 105 km² within the central NL ecoregion, which covers the north-central part of Newfoundland. The ecoregion is heavily forested with peatlands occurring commonly throughout. The topography is gently rolling to hilly and underlain by acidic bedrock. This ecoregion is the most continental part of the island, having the highest mean summer temperatures (12.5°C) and lowest mean winter temperatures (-3.5°C). Because of the warm summers and high evapo-transpiration rate, soils in the northern part of this ecoregion exhibit soil-moisture deficiency and forest fires have played a more important role in the ecoregion's natural history than in other regions. Balsam Fir (*Abies balsamea*) and Feather Moss (*Hypnaceae sp.*) dominate moist upland slopes while Black Spruce (*Picea mariana*), White Birch (*Betula papyrifera*), and Trembling Aspen (*Populus tremuloides*) often grow on disturbed sites. In areas that have been burned repeatedly, dwarf shrub (*Kalmia*) barrens have replaced forest stands. Some areas lack good forest growth due to exposure to winds and poor soil conditions. Black Bear (*Ursus americanus*), Caribou (*Rangifer tarandus*), Moose (*Alces alces*), Lynx (*Lynx canadensis*), and Red Fox (*Vulpes vulpes*) are typical wildlife species inhabiting the ecoregion.

It has been known that productive wetlands exist within the boundaries of the Town of Gander and, as a result, in 1992 the Town expressed an interest in participating in the Municipal Habitat Stewardship Program. Subsequently, field surveys were conducted to identify potential wildlife 'hotspots' through discussions with local residents, birdwatchers, and the Wildlife Division staff. Preliminary field surveys were then conducted within those areas to assess their importance as waterfowl habitat. This information and subsequent negotiations with the municipality and the Wildlife Division resulted in the signing of a Stewardship Agreement on June 22, 1993 in which two 'Management Units' (Cobb's Pond and Northwest Bog) within a greater 'Stewardship Zone' were set aside for conservation. Since that time, the Town of Gander has further amended its Stewardship Agreement on two occasions. On Sept 10, 1997, the Town expanded the scope of its Management Units to include a wetland constructed in Benton for waste water treatment. Again on March 14,

2007, the Town of Gander further expanded its Stewardship Agreement to include Peyton's Pond and Whitman's Pond as additional Management Units due to their high importance for waterfowl nesting and brood-raising.

Description of the Stewardship Zone

** An overview map showing the Stewardship Zone is found in Appendix 2.*

The Gander Stewardship Zone was created to assist the Town with its decision making; providing awareness of the effects of development on wetlands and waterfowl. The Stewardship Zone encompasses a total area of approximately 1,742 hectares (4,304 acres) (see Appendix 2). The Stewardship Zone comprises of most of the major wetlands within the western portion of the Town's Municipal Planning Boundaries. These wetlands are inhabited and utilized by a large number of wildlife, including waterfowl and songbirds. Within the Stewardship Zone some significant wildlife habitats are identified and are known as Management Units. These Management Units include Northwest Bog, Whitman's Pond, Peyton's Pond and Cobb's Pond (Appendix 2).

Habitat within the Stewardship Zone is typical of that found in the North-central subregion. These areas are most commonly frequented by stands of Balsam Fir (*Abies balsamea*), Black Spruce (*Picea mariana*), White Spruce (*Picea glauca*), and Trembling Aspen (*Populus tremuloides*) with Sheep Laurel (*Kalmia angustifolia*) and Schreber's Moss (*Pleurozium schreberi*) ground cover. Other common emergent and submergent vegetation include Sedges (*Carex spp.*), Cotton Grass (*Eriophorum spp.*), Bulrush (*Scirpus americanus*), Rushes (*Juncus spp.*), Horsetail (*Equisetum fluviatile*), Goldenrod (*Solidago spp.*), Blue Flag Iris (*Iris versicolor*), Bullhead Waterlily (*Nuphar variegatum*) and Pondweed species (*Potamogeton spp.*).

Description of the Management Units

** An overview map showing all Management Units is found in Appendix 2.*

Management Units are areas of critical importance to waterfowl, generally providing prime habitat for nesting and brood rearing. These areas in Gander also represent areas of importance to town residents, as well as visitors to the area and without these areas a great number of bird populations, including waterfowl, songbirds, and other wildlife in the community would suffer.

The Town of Gander has five Management Units within their Planning Boundaries; they include Northwest Bog, Cobb's Pond, Whitman's Pond, Peyton's Pond and the constructed wetland in the community of Benton which has an approximated size of 351 hectares (868 acres). These areas are identified as having important nesting and brood-rearing habitat for a large number of waterfowl species. Some common wildlife species observed in the area include American Black Duck (*Anas*

rubripes), Ring-necked Duck (*Aythya collaris*), Green-winged Teal (*Anas crecca*), Canada Goose (*Branta canadensis*), Common Loon (*Gavia immer*), Beaver (*Caster canadensis*), Mink (*Mustela vison*), River Otter (*Lutra canadensis*) and Muskrat (*Ondatra zibethicus*).

Northwest Bog Management Unit

The Northwest Bog Management Unit (Figure 1) (Figure 2), located in the western portion of the Town's Planning Boundaries, encompasses approximately 42 hectares (104 acres) of wetland habitat. When the Stewardship Agreement was signed by the Town in 1993 the area was identified by local residents as being a staging area for Canada Geese (*Branta canadensis*) during spring and fall migration.

Habitat in the area is classified as raised bog with open areas of grass and sedge species, with closely grouped 'pothole' bodies of water (Figure 3). The area is mostly dominated by Caribou Lichen (*Cladina rangiferina*), Sphagnum Moss (*Sphagnum spp.*), Black Spruce 'tuckamore' (*Picea mariana*), Leather Leaf (*Chamaedaphne calyculata*), Pitcher Plant (*Sarracenia purpurea*), common grass species including Cottongrass (*Eriophorum vaginatum*) and ericaceous plants like Labrador Tea (*Ledum groenlandicum*) and Bog Laurel (*Kalmia polifolia*).

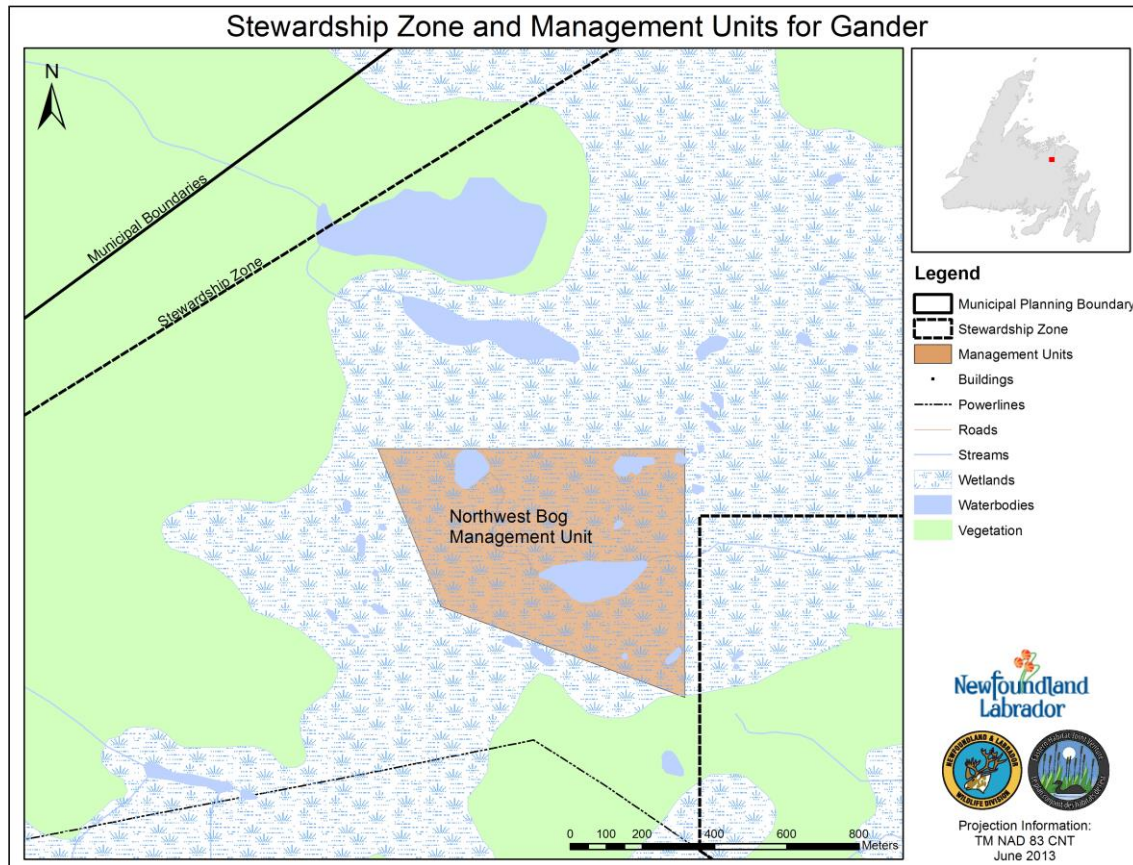

Figure 1 - Map of the Northwest Bog Management Unit



Figure 2 - Aerial Photo of the Northwest Bog Management Unit



Figure 3 - A portion of the Northwest Bog Management Unit. Photo by: Charmaine Barney

Cobb's Pond Management Unit

The Cobb's Pond Management Unit (Figure 4) (Figure 5) is located south of Northwest Bog in the southern portion of the Town's Stewardship Zone and is approximately 90 hectares (225 acres) in size. Prior to the signing of the Stewardship Agreement in 1993, the area was identified as having adequate nesting, feeding and brood rearing habitat for a number of waterfowl species. The area continues to be a highly productive area for many wildlife species.

Cobb's Pond is also a well known Municipal Park having a boardwalk nature trail around the perimeter of the pond and is visited by thousands of people every year. The park also has picnic areas, playgrounds and several observation decks, and cavity nest boxes scattered around the vicinity of the pond. Cobb's Pond is also used for canoeing and kayaking in the summer and cross-country skiing on the trails in the winter.

Despite the amount of usage in the area, Cobb's Pond is fairly productive and is consistently utilized by waterfowl and other wildlife species, such as Ring-neck Duck (*Aythya collaris*), nesting Common Loon (*Gavia immer*) (Figure 6), broods of American Black Duck (*Anas rubripes*) (Figure 7) and Green-winged Teal (*Anas carolinensis*) (Figure 8) and Beaver (*Castor canadensis*). It is, however, important to note that high levels of human disturbance during the nesting and brood rearing periods (late April to mid-July) may have a detrimental impact on the number of broods produced in the area. When adult waterfowl become disturbed, they will often abandon their nests, leaving their broods very susceptible to predation.

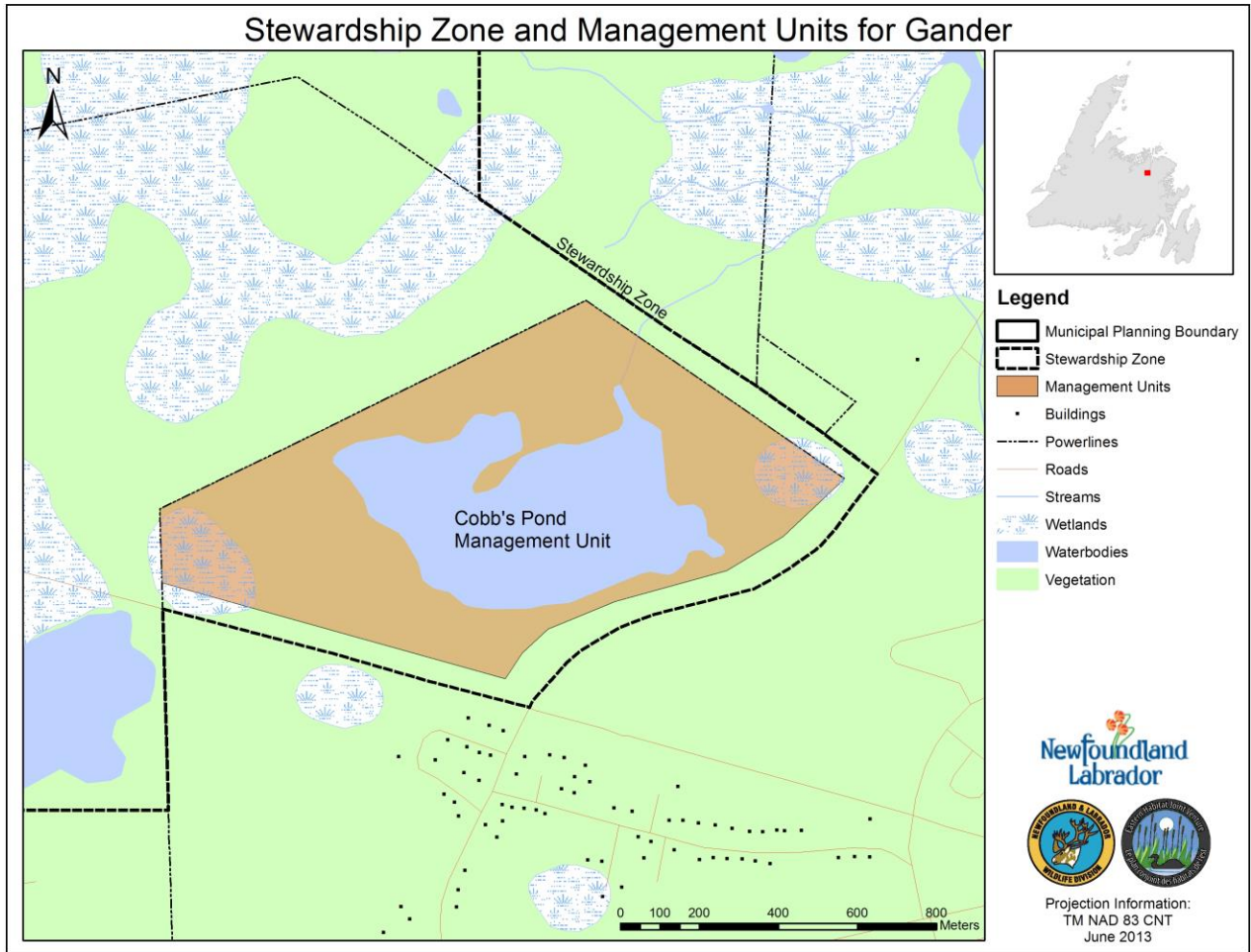

Figure 4 - Map of the Cobb's Pond Management Unit



Figure 5 - Aerial Photo of the Cobb's Pond Management Unit



Figure 6 - Nesting Common Loon in Cobb's Pond. Photo by: Charmaine Barney



Figure 7 - Brood of American Black Ducks in Cobb's Pond. Photo by: Charmaine Barney



Figure 8 - Brood of Green-winged Teal in Cobb's Pond. Photo by: Charmaine Barney

Benton (Constructed Wetland) Management Unit

The Management Unit (Figure 9) (Figure 10) is located in the community of Benton, but within the Municipal Planning Boundaries of Gander. The Town’s existing Stewardship Agreement was amended in 1997 to include the constructed wetland area. The Benton Management unit is an approximately 200 meter buffer around the water control structure located in the constructed wetland. The wetland was put in to place to provide tertiary treatment for the effluent from the secondary sewage treatment facility. The nutrients from the secondary system would be utilized to reduce bacteria and nitrate loading from the sewage outflow and establish a wetland for waterfowl and other wildlife. The area was also planted with vegetation such as Hardstem Bulrush (*Scirpus acutus*), Yellow Iris (*Iris pseudacoris*) and Sago Pondweed (*Potamogeton pectinatus*) that provide habitat for wildlife, as well as wastewater treatment. (Figure 11)

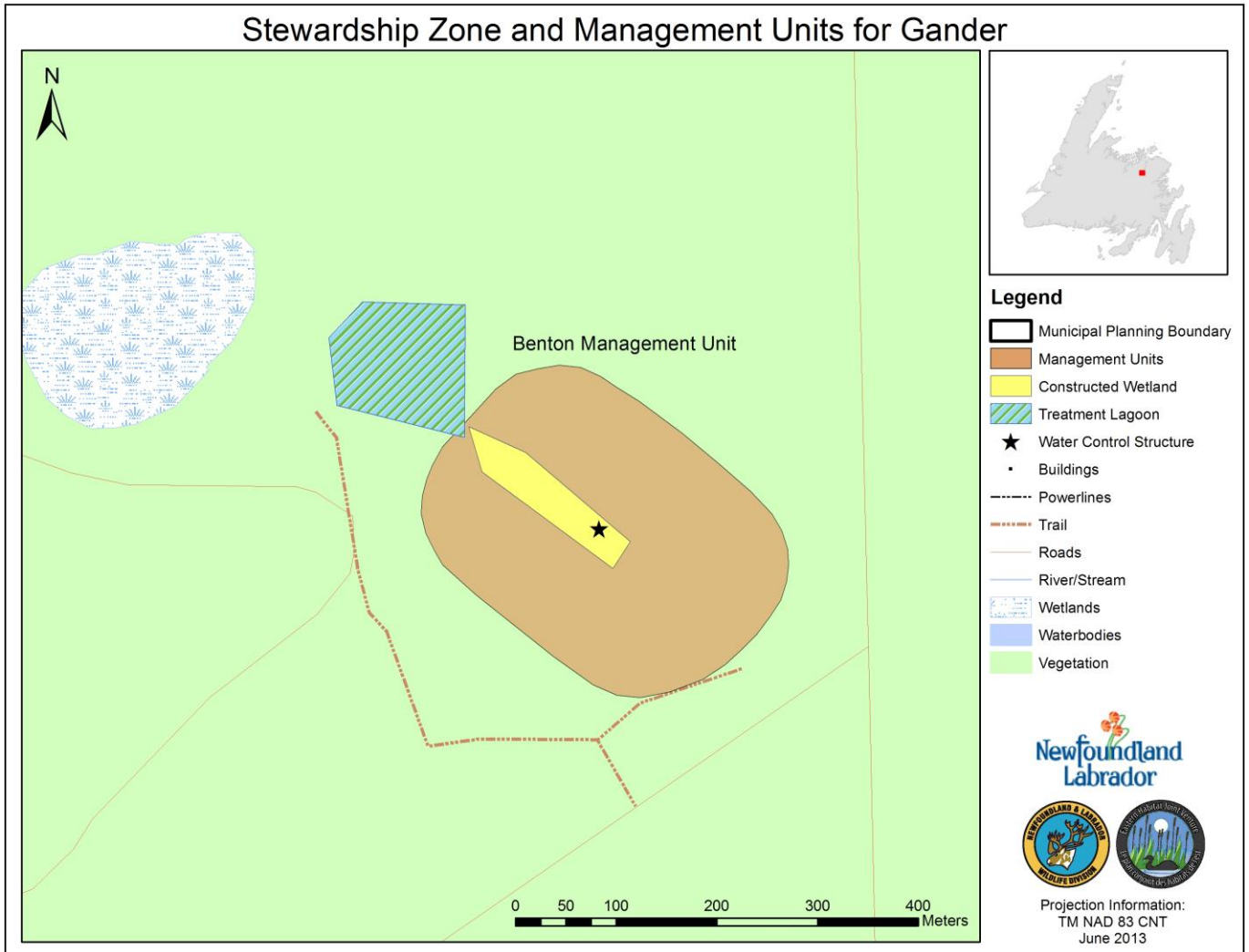

Figure 9 – Map of the Benton (Constructed Wetland) Management Unit



Figure 10 - Aerial Photo of the Benton (Constructed Wetland) Management Unit



Figure 11 - Benton's (Constructed Wetland) Management Unit. Photo by: Charmaine Barney

Whitman's Pond Management Unit

The Whitman's Pond Management Unit (Figure 9) (Figure 10) was added to Gander's amended Stewardship Agreement in 2007 and is approximately 193 hectares (477 acres) in size, the biggest Management Unit in the Town. The Management Unit extends 100 meters from the high water mark around the entire perimeter of the pond, including the southern extremity as well as the five ponds associated with the northern extremity of Whitman's Pond. During this time the area, particularly the upland habitat north and south of the pond, was formally recognized as having ideal nesting, staging and brood raising habitat because of its rich supply of aquatic invertebrates and plants and adequate cover to protect birds from predators and harsh weather conditions.

Several old cabins, in deteriorating condition, are located near Whitman's Pond and trout fishing is popular in the pond throughout the summer. Human disturbance during the nesting and brood rearing periods may disturb birds and increase mortality of the young. Given that this is a large waterbody and there are many locations for anglers to fish, anglers and others using the area should be advised to avoid disturbing the areas where the birds are nesting and rearing broods. Litter from the cabin sites may also negatively impact waterfowl in the area and it is recommended that the area be cleaned up.

An old growth forest surrounds the pond with a moss-covered understory. Shallow water and marsh habitat are also characteristic of the area with common grasses and rushes bordering the pond. Submergent and emergent vegetation, such as common pondweed and sedges, Blue Flag Iris (*Iris versicolor*), Cattails (*Typha latifolia*), Bedstraw (*Galium spp.*), Eel Grass (*Zostera marina*) and Bullhead Water Lilies (*Nuphar spp.*) can also be found in the Management Unit. (Figure 11) Some waterfowl species recorded to inhabit the area include American Black Duck (*Anas rubripes*), Green-winged Teal (*Anas carolinensis*), Ring-necked Duck (*Aythya collaris*) and Common Loon (*Gavia immer*). Moose (*Alces alces*), Fox (*Vulpes vulpes*) and Beaver (*Castor canadensis*) are some other wildlife that was observed in the area.

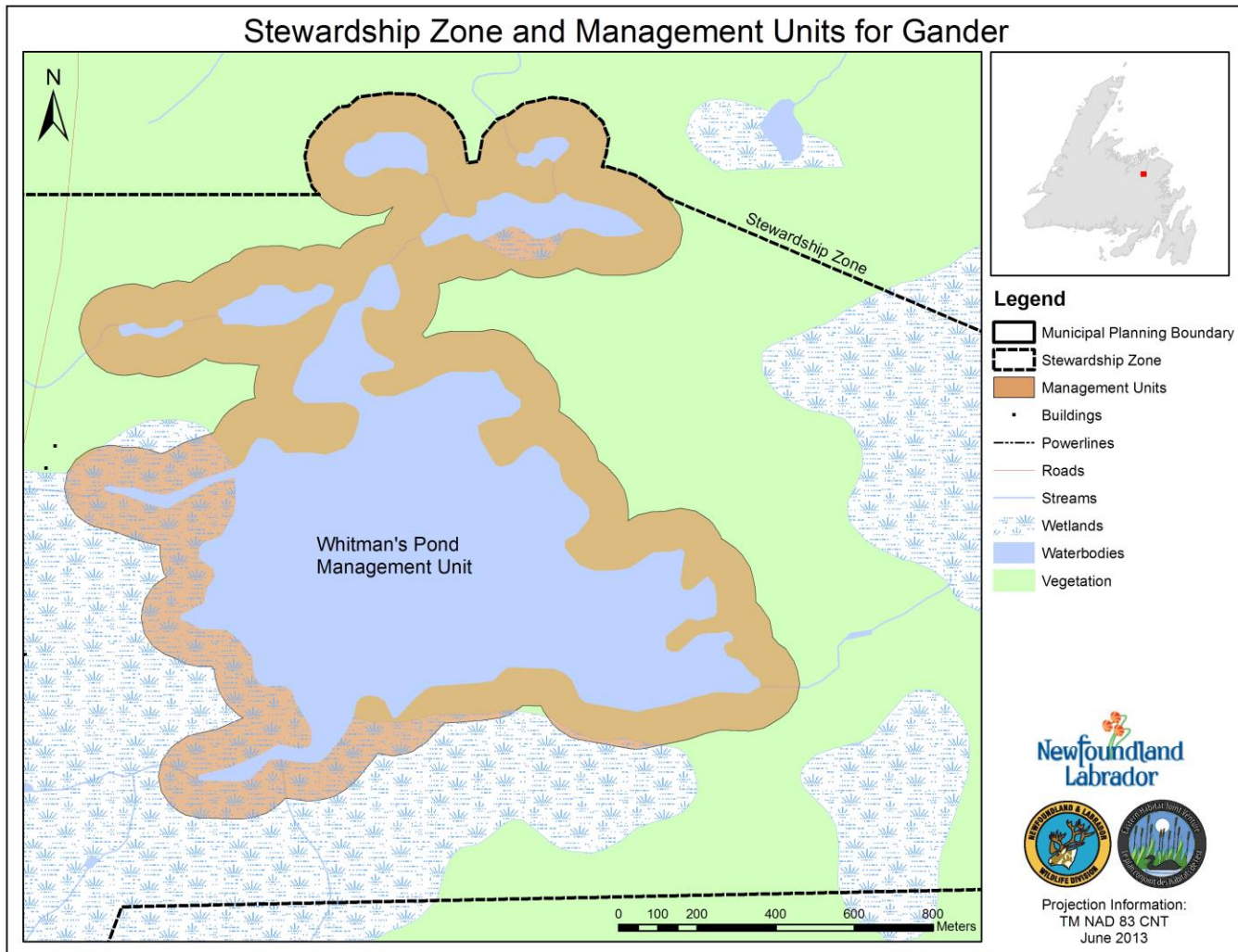

Figure 12 - Map of the Whitman's Pond Management Unit.



Figure 13 - Aerial Photo of the Whitman's Pond Management Unit.



Figure 14 - Looking north at Whitman's Pond Management Unit. Photo by: Charmaine Barney

Peyton's (Long) Pond Management Unit

Peyton's Pond Management Unit was also added to the amended Stewardship Agreement in 2007 and was delineated based on the Town's 'Open Space Conservation' zoning in Gander's Municipal Plan and Development Regulations (2000 – 2010). The area encompasses Peyton's Pond, as well as the upland habitat south of the pond (Figure 12) (Figure 13) and is approximately 17 hectares (42 acres) in size.

The shallow water pond is surrounded predominantly by a Cattail (*Typha latifolia*) marsh, with over half of the vegetation consisting of emergent vegetation, such as Larch (*Larix laricina*), Balsam Fir (*Abies balsamea*), Spruce (*Picea spp.*), Alder (*Alnus spp.*), Blue Flag Iris (*Iris versicolor*) and Sedges (*Carex spp.*). The area has a rich supply of aquatic invertebrates and plants that provide adequate cover in protecting nesting birds from predators and harsh weather conditions. All of these characteristics make the site exceptional for nesting, staging and brood-rearing for numerous waterfowl species, including American Black Duck (*Anas rubripes*), Green-winged Teal (*Anas carolinensis*), Mallard (*Anas platyrhynchos*), Ring-necked Duck (*Aythya collaris*) and American Bittern (*Botaurus lentiginosus*).

Nest boxes for cavity nesting waterfowl have been placed around the perimeter of the pond, however given the existing waterfowl usage, little habitat enhancement is required in the area. The most important conservation initiative in this area will be continuing to preserve the area through community education and awareness.

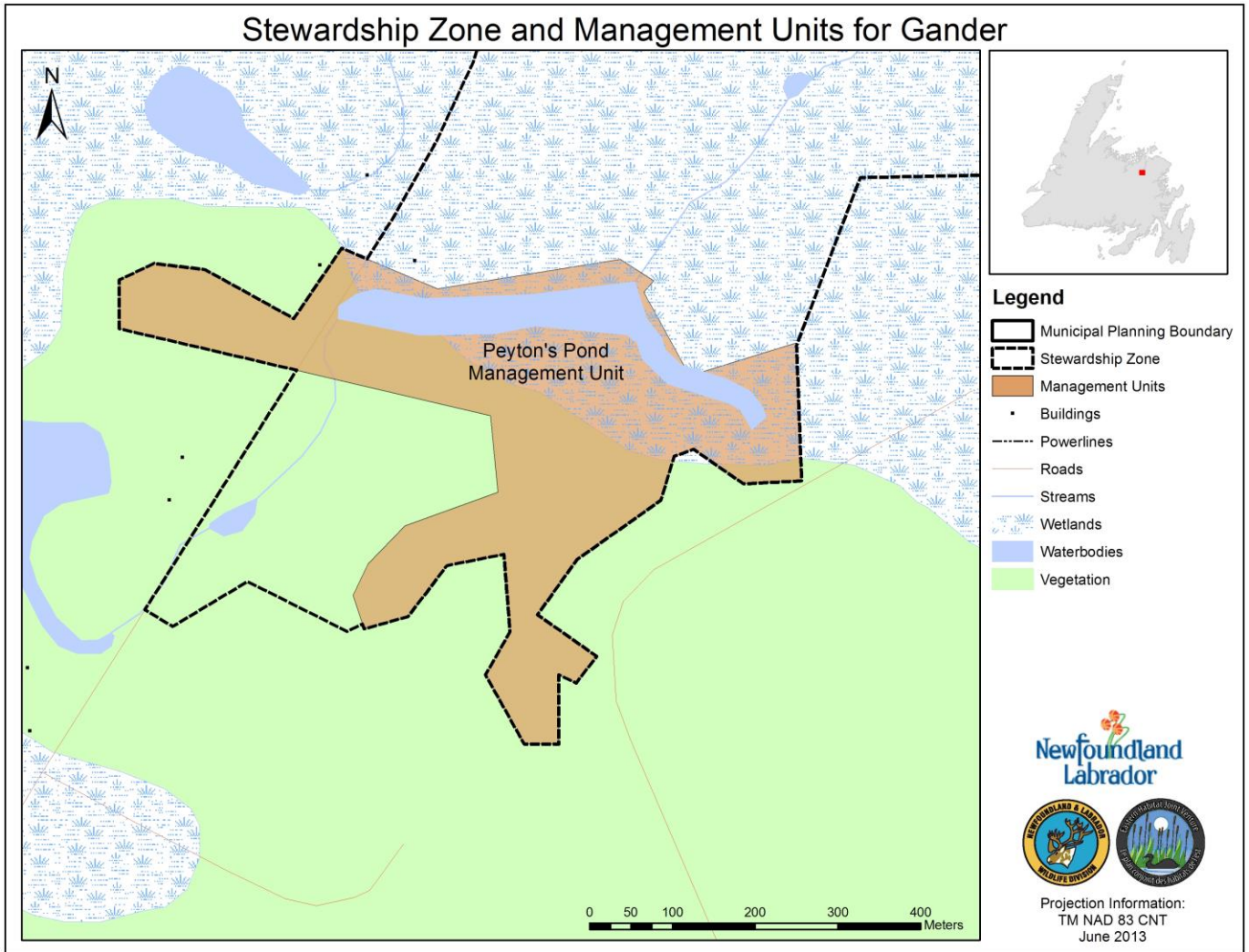

Figure 15 - Map of Peyton's Pond Management Unit.



Figure 16 - Aerial Photo of Peyton's Pond Management Unit.



Figure 17 - Peyton Pond Management Unit. Photo by: Charmaine Barney



Figure 18 - American Black Ducks in Peyton's Pond. Photo by: Jessica Humber

Section 4: General Policies for Wetland Conservation

The Town's Commitment to Stewardship

In signing a Municipal Habitat Stewardship Agreement, the Town has made a public commitment to join an international network of important wetland habitat areas contributing to waterfowl presence and abundance in North America. Further, the Town of Gander has committed to using this Habitat Conservation Plan as a guide to best management practices in and around wetlands, and associated uplands, significantly within the Town's Management Units. Perhaps most significantly, it is hoped that a stewardship ethic will be fostered within the community since the conservation of wildlife habitat depends not wholly on Habitat Conservation Plans or regulations, but on the conservation and stewardship ethic of Town residents and of visitors.

The Management Units will be managed to ensure the maintenance and possibly the enhancement of wetland habitat and waterfowl populations. Managing bodies will include the Town Council and the Department of Environment and Conservation, Wildlife Division.

Benefits for Residents

The strategies outlined in this Habitat Conservation Plan can provide many long term recreational and "quality-of-life" benefits for local residents. Wetland habitats are often ideally suited to a variety of consumptive and non-consumptive recreational activities, including fishing, hiking, canoeing, photography and bird-watching. The Town may wish to use these opportunities to increase tourism to the region. In developing employment, recreational and tourism opportunities, careful consideration for wildlife populations must be included in the planning process. Otherwise, human activities may result in negative impacts to the very resource that is providing the attraction.

Surely the most important benefit that people receive from stewardship is the opportunity to increase their knowledge of wetlands and nature in general. Programs such as the Canadian Wildlife Federation's "Project Wild" foster an increased environmental ethic in youth and adults alike. Many of the enhancement and restoration strategies outlined in this plan can be easily conducted by local community interest groups, thereby allowing "hands on" involvement in conservation efforts.

Management of the Stewardship Zone

Activities within the Stewardship Zones will be managed so as to minimize impacts on wetlands, waterfowl or wildlife populations. Development proposals which, in the view of council, may negatively impact wetland habitat, waterfowl or wildlife within the area can, at the discretion of council, be forwarded to staff of the EHJV for comment with a thirty (30) day notice period.

Management of the Management Units

Activities within the Management Units will be managed whereby permitted activities do not result in the loss of wildlife habitat or wildlife populations. As such, wildlife will be at the forefront of management decisions. Should they be necessary, efforts will be made to reduce pre-existing habitat degradation within Management Units and only activities that have no negative or adverse impact upon wetland and associated upland habitat, and on the associated wildlife using those habitats, should be permitted in these areas. Development proposals which impact habitat or wildlife within the Management Units should be forwarded to staff of the Wildlife Division for comment with a thirty (30) day notice period.

Incorporation of Management Units in Municipal Plans

During the preparation of a draft Municipal Plan, or during the process of Municipal Plan Review, the Town Council shall incorporate the Stewardship Agreement into any resulting Municipal Plan or related "Master Plan". Specifically, the Management Units, and any future Management Units as may be desirable, shall be declared "conservation areas" or some similar consistent zoning designation. If such areas are outside municipal planning boundaries, the town could seek to have them designated "Protected Areas" under subsection 31 of the Urban and Rural Planning Act, 2000.

In approving permits, regulations or by-laws related to the area's designation within a Municipal Plan, or any amendments to a future Municipal Plan which could affect the Management Units, the Town Council will consult with staff of the Wildlife Division providing a thirty (30) day window of notice for comment.

Riparian Buffers in the Management Units

Riparian buffers are generally strips of untouched vegetation occurring between upland areas and wetlands, lakes, rivers, ponds and streams. They are composed of trees, shrubs, grasses, cattails and sedges and often possess a high level of wildlife use, generally as "corridors" for travel, for protection from predators and against inclement weather. These areas filter and reduce surface water runoff from upland areas, trapping sediment and filtering out excess nutrients, pesticides and bacteria. Vegetation in riparian areas also affects how readily water enters soil and has a positive effect over the replenishing of local groundwater. They also serve to anchor

soil with its roots, helping to build stream banks and prevent erosion. They are often important in controlling flood levels and are critical to a variety of plants and animals. Fish habitat quality is also influenced by the amount of riparian edge left along shorelines. Treed buffers provide shade and serve to keep water temperatures down, also impact water quality; they provide spawning and rearing areas for fish species, and nesting areas for waterfowl. They also serve as a food source for a variety of wildlife when leaves and insects/insect larvae drop into the water body off of surrounding trees and shrubs.

The province, via the provincial Lands Act – Section 7(1), generally requires a crown land reserve or easement of 15 metres along all water bodies greater than 1m in width and the maintenance of permanent riparian areas next to watercourses within the province. It is important that the town ensures awareness and adherence to this crown land reserve designation by all of its residents. The vegetated (untouched) buffer exists as the minimum protection around all waterbodies and marsh areas and is considered critical within the designated Management Units. Agriculture and cabin development seem like the two most likely disturbances to riparian vegetation.

Management by Committee

It is recommended that Town's seek to manage their agreement and the implementation of this Conservation Plan via a formal committee of council. This may take the form of an "Environment Committee" or "Wetlands Committee" generally chaired by a member of council with volunteers from the local community making up the remainder of its membership. It has been our experience that such, often dedicated and dynamic, committees often have greater success in raising the profile of the environment and the wetland protected areas within the larger community, working with council, thereby increasing public understanding and support over the long-term. By involving local individuals a greater sense of ownership is fostered thereby strengthening the conservation commitment.

Stewardship Association of Municipalities Inc. (SAM)

When a municipality signs a Municipal Habitat Stewardship Agreement, it becomes eligible to become a member of the Stewardship Association of Municipalities Inc., also known as "SAM". SAM is an incorporated, non-profit organization whose membership is comprised of Newfoundland and Labrador municipalities. Each member municipality has also made a formal commitment to the conservation of habitat and biodiversity within their municipal planning boundaries by signing a Municipal Habitat Stewardship Agreement with the provincial Department of Environment and Conservation.

SAM member municipalities together seek to secure, enhance and restore important wildlife habitat in the province while balancing municipal development with

conservation. SAM also represents its members on issues of common concern related to provincial wildlife habitat conservation. Additionally, as part of the implementation of their individual Municipal Plans, Stewardship Agreements and associated Habitat Conservation Plans, member municipalities seek to educate and engage residents, particularly youth, in environmental stewardship and conservation. This is in recognition that the involvement and support of local people can and has, had a significant positive impact on a wide variety of conservation issues.

The Association meets bi-annually with meetings rotating among member communities. We encourage you to become an active member of SAM by identifying a representative of your town to attend at least one of these meetings per year. This will serve as a significant connection for your town to provincially like-minded municipalities and link you to resources and training related to ongoing provincial conservation initiatives.

Section 5: Wetland Conservation and Education Strategies

Waterfowl Monitoring Project

Staff of the Wildlife Division has devised an easy to use community-based waterfowl monitoring protocol and are willing to assist community partners in its implementation (Appendix 3). It is hoped that Town's, local community interest groups and interested volunteers (often bird-watchers) will establish a waterfowl monitoring program within all areas of the Town but, particularly, within the designated Management Units. The program could even be incorporated into portions of the regular school class curriculum or into the objectives of local natural heritage organizations. Data collection can provide information on changes that are occurring within the wetland area and can indicate problems or progress towards a desired goal of waterfowl populations. Monitoring can also provide data on whether a site is developing in a way that is conducive to achieving a community's goal. Regular monitoring can also be a way to flag potential problem areas (i.e. early indicators of water quality issues). Additionally by involving local residents, the profile of the area is enhanced to the long-term benefit of conservation.

Conservation Corps Green Teams

The Newfoundland and Labrador Conservation Corps annually sponsors summer "Green Teams" and "Interns" generally comprised of university and high school students, to work within communities on worthwhile environmental projects. In the past, such teams have been placed in communities with Stewardship Agreements. Examples of potential projects could include constructing and installing waterfowl nest boxes and nesting platforms [for Canada Geese (*Branta canadensis*)] followed by subsequent monitoring throughout waterfowl breeding/brood-rearing seasons. Green Team members could be tasked with training local high school students or community members in appropriate monitoring protocol and could develop brochures and educational material (see example of an interpretative sign designed by the Wildlife Division in Appendix 4) designed to raise awareness for conservation and stewardship initiatives. This project could be extended to bird houses and would serve to provide data on birds using various habitats within the entire community.

Artificial Nesting and Loafing Structures

Ospreys

Ospreys (*Pandion haliaetus*) are fish eating raptors that are frequently observed hunting in wetland habitats, particularly areas along the coast. Unfortunately, populations of these birds plummeted in North America during the 1950's and 1960's due to the wide spread use of pesticides and other pollutants which have a tendency to bioaccumulate in birds of prey, like the osprey. For many osprey populations, bioaccumulation results in frequent reproductive failures. With the banning of many pesticides in the early 1970's, many osprey populations have made a comeback.

Osprey prefer to nest on tall, often dead, trees on the shoreline of lakes and bays that are at least 2 metres deep but make nests in a multitude of locations (i.e. telephone poles, communication towers, etc.) as long as the area is wide open with an adequate food supply. Preferred natural sites are scarce due to timber harvesting and shoreline developments.

In many parts of Canada, the installation of artificial nest structures (Figure 16) by concerned citizens and community groups have facilitated the comeback of the osprey. Osprey nest structures have been installed at several sites in Newfoundland, including many municipal stewardship communities. Many people take great pleasure in watching these majestic birds raise their family and fish the shallow waters of nearby lakes and bays.

It may be advisable to install a single osprey platform at a carefully chosen location to determine whether the ecosystem can sustain a single, monogamous, breeding pair of osprey, with subsequent platforms planned accordingly. In conjunction with an observation tower, area residents could potentially enjoy a "bird's eye view" of osprey daily life high atop an artificial nesting structure. Artificial nesting platforms should be located in areas with minimal human use and where human impact would be least. Involvement of schools, youth groups and community organizations in the construction/maintenance/observation of the nesting structure could instill a sense of pride and awareness that would go far in fostering a community stewardship ethic.

See Appendix 5 for the design and placement of Osprey nesting platforms.



Figure 19 – Osprey nesting platform in Stephenville Crossing. Photo by: Charmaine Barney

Island Construction

A number of wildlife species, such as terns and waterfowl, nest and loaf on islands due to a reduced risk of predation from land-based predators. Many of the wildlife species present within wetlands would benefit from the construction of artificial islands. These structures can be constructed simply from wooden cribs (Tamarack Larch would be an appropriate choice for building material), measuring approximately four square meters that have been filled with rock and soil. The islands must be positioned so that they are higher than the highest water mark. Hardy shrubs and herbaceous plants (i.e. alder, willow) must be planted on the islands to provide cover and to prevent occupancy from gulls. Care must be taken to prevent the use of toxic construction materials (i.e. treated wood, contaminated soils) and disturbance to plant and animal communities. One must also consider the potential for increased predation on certain avian species that may use the constructed islands. One must consider the potential necessity for annual removal and reinstallation of islands in response to ice conditions tidal influenced areas.

Other forms of artificial islands exist and involve the planting of native marine plant species into landscaping fabric, which is then fixed to floating structures made of plastic piping or empty gabion baskets. This type of floating island requires careful placement in areas that do not have widely fluctuating salinity levels and require placement such that disturbance would be minimal during the period in which roots are establishing. Floating islands may be beneficial in terms of oxygenating the water column, as algal blooms would not “smother” the highly perched plants. The floating plants should, ideally, continue photosynthesizing despite the presence of algae, and may be of benefit in “taking up” some of the excess nutrients in the estuary effectively deterring algae growth. These floating islands would also, likely, require annual removal and reinstallation.

Cavity Nesting Waterfowl

Cavity nesters such as the Common Goldeneye have certain habitat requirements for nesting. When available they use abandoned woodpecker holes or natural tree cavities caused by disease, fire or lightning. In the absence of these natural cavities, they will use constructed nest boxes (Figure 20). These shelters, however, need to be installed correctly and placed in a location that is inhabited with waterfowl.

When installing nest boxes, there are important guidelines that are to be followed (see Appendix 5). These guidelines will help increase the success of nest box usage. When nest boxes are to be installed, the Wildlife Division staff often includes a map where the nest boxes should be placed to encourage use by the target duck species. It will also help ensure that the placement of nest boxes will enhance wetlands that are included in the Stewardship Agreement signed by the community.



*Figure 20 – Cavity Nest Box in Cobb’s Pond, Gander.
Photo by: Charmaine Barney*

As a general rule, we ask that the location of the nest boxes be marked using a global positioning system (GPS). If the community requires assistance they can contact the Wildlife Division or a local conservation officer. It is very important that we receive coordinates for nest boxes for reporting and maintenance purposes.

Nest boxes can be mounted on tree trunks (preferably dead but solid trees) that extend slightly over the water's surface. Nest boxes may be placed on metal poles close to the edge of a pond, but we advise extreme caution in this situation so that snowmobilers do not run into your poles during winter months. If there is even a slim chance that someone could run into the metal pole, we suggest that you find another way to install your nest box.

Good placement would involve a dead tree standing along a shore. Better placement would be on a solid tree standing in water. Suitable placement would also be on a metal pole in a safe area (with no danger of being hit by motorized vehicles), on a shoreline next to a dead or flooded tree, firmly planted into the pond or marsh bottom. Boxes can be placed on live spruce or larch, but may loosen as the tree continues to grow. If using a live tree, remember to clear away limbs from just on top of the box so that squirrels and marten don't end up jeopardizing the lives of your ducklings. Keep in mind that beaver may chew live hardwoods like birch, so placement on these trees should be avoided, as you will soon be wondering where your nest box went!

Boxes should be placed above typical high water levels at a height that still allows you to clean (annually) and monitor the boxes. Ideally, boxes will be placed as high as possible, but at least 4 to 6 feet above the water's surface. Boxes should be placed on trees that bend slightly over the water's surface. When ducklings are ready, the adult will force them out of the entrance of the nest box and it is important that the box be positioned appropriately or the duckling may not fledge successfully and an ill-placed box has been known to actually jeopardize lives of ducklings.

Try to keep your nest box close to water and clear a path (of any small branches, etc.) so that ducks have a direct line of access from the water. The entrance hole should face the water. Do not place boxes so close together that competition will occur. As a rule, boxes should be placed no closer than 50 meters apart (one nest box per acre is considered acceptable) and shouldn't be placed where ducks can see each other from neighboring boxes.

Boxes must be maintained every year (with winter months being the preferred time for maintenance) by scraping out old planar shavings and replacing with new, clean, planar shavings. It is very important not to use sawdust as the pieces are too small and can actually suffocate ducklings. A garden store or sawmill would be an easy source for planar shavings or mulched wood. Eight to ten centimeters of clean wood shavings should be placed in the bottom of the box before breeding season. Hens will actually reject nest boxes that do not have shavings, and eggs could freeze if there are not enough shavings in the bottom of the box.

Common Goldeneye will raise multiple broods in a well-maintained and suitably placed nest box. If you are lucky, you will actually get to see ducklings leaving the box (although you should avoid approaching the nest box to check on its use during important times like hatching and fledging), but mostly you will find signs left in the

box when you prepare for its annual maintenance. You should look for light coloured duck down, bits of egg shell or shell-membrane (like a piece of paper) left behind when duckling hatch and mixed up wood shavings. Ducklings in the area indicate there are ducks and it is quite possible that they have used the nest boxes provided. It is also a great idea to keep in mind that other birds and small mammals may have used the nest boxes as well.

Installing nest boxes is a very exciting activity to help enhance waterfowl in the conservation areas around your community. It does, however, take time, commitment and maintenance and if any technical advice or help is needed it is advised to contact the staff of the Wildlife Division. See Appendix 5 for the design and maintenance of cavity nest boxes.

Roosting and nesting structures for non-waterfowl species

There are a variety of roosting and nest structures (Appendix 5) which can be built, installed and monitored/maintained for non-waterfowl species such as those that might be appropriate for birds like Tree Swallows (*Tachycineta bicolor*), Northern Flicker (*Colaptes auratus*), for owls like the Great Horned (*Bubo virginianus*) and for bats (Figure 21). This would prove beneficial to local farmers in that many bird species (and bats) feed on insects and may serve as natural pest control. In addition, providing nests for certain birds may also help reduce (or keep in check) populations of birds that may not be desirable to farmers [i.e. American Crow (*Corvus brachyrhynchos*), European Starling (*Sturnus vulgaris*)] and rodents (i.e. mice) while increasing biodiversity on the agricultural landscape.



Figure 21 – Bat Roosting Box in Salmonier Nature Park. Photo by: Wildlife Division Staff

The materials and measurements needed for the construction of nest boxes for cavity nesting waterfowl, bats and tree swallows are provided in Appendix 5.

Educational Programs

Public education is essential in the development of a greater sense of habitat stewardship among town residents. There are several well developed wetland education programs that span every season and every age group including “Wetlands in Winter” (Tantramar Wetlands Centre), “Marsh Bingo” and “Creatures of the Night” (Oak Hammock Marsh Interpretive Centre), “Junior Naturalists” (Wye Marsh Wildlife Centre), “Project Webfoot” (Ducks Unlimited Canada). A number of night programs also exist that would be appropriate for girl-guide and scout troupes. Certain programs may qualify for external funding through various private enrichment grants (i.e. Mountain Equipment Co-op or the Canadian Wildlife Federation).

Project Wild

Project Wild is an educational program conducted by the Newfoundland and Labrador Wildlife Division and is aimed at youth from kindergarten to grade six. Its goal is to develop awareness, knowledge, skills and commitment resulting in

informed decisions, responsible behavior and constructive actions concerning wildlife and the environment upon which all life depends. Project Wild is not just "wildlife" education. It is a broad environmental education program focusing on wildlife. Wildlife is used as a tool that naturally captures student interest and as a symbol for the fragility of the environment providing a means to also educate youth about the value of wetlands for waterfowl.

Backyard Habitat for Canada's Wildlife

This habitat awareness initiative is made available by the Canadian Wildlife Federation and is administered in conjunction with the Wildlife Division's Salmonier Nature Park. This program enables the average towns person to become an active participant in helping wildlife and in enhancing habitat for wildlife use. Backyard Habitat for Canada's Wildlife is a program that offers immediate, specific and inexpensive suggestions on how to make life better for wildlife in a particular habitat.

Nature and Art

Some stewardship communities have used the wetlands and associated wildlife as opportunities to also serve as a natural location to bring together nature and art. This is made much simpler if a central building or interpretation area is present on site. Local art classes and drama groups use the freedom afforded by an outdoor theatre for educational exercises. This could involve field trips whereby students could interpret the beauty of wetlands - and nature in general - through various mediums (chalk, paint, etc.) or a day of sketching to the sound of nature or music. Being innovative in efforts to assemble art supplies might include visiting websites like Crayola.com which offer special resource grants to educators.

Similarly, drama classes could develop a play or a series of dramatic readings based upon wetlands or nature with evening delivery within a lighted amphitheatre. Several amphitheatres in Eastern Canada utilize the open-air concept to show nature-related videos or videos with an environmental message outdoors in the evening. Videos could be tailored to various ages and could include nature-related craft projects within the Eco-museum shelter as a follow up. A good starting point for videos and educational nature-oriented craft projects for children may include websites like hookedonnature.org and planetpals.com.

Ducks Unlimited Canada's Youth Programs

Project Webfoot

Educating youth about wetlands and waterfowl is a big part of Ducks Unlimited Canada's mission. The award-winning Project Webfoot Wetland Education Program is a comprehensive program linked to the senior elementary curriculum in grades 4 to 6 (habitats & communities, biodiversity, food webs and adaptations). Learning resources and field trips to a local wetland are available to sponsored classes. There are also many teacher and student resources for Grade 4 through high school on the Ducks Unlimited website (www.ducks.ca). These downloadable files are easy to navigate and provide great linkages with school curriculum.

Wetland Heroes

Another program offered through Ducks Unlimited includes Wetland Heroes which take action to protect wetlands for wildlife and people in their local community. Whether you're one person, a group of friends, a class, club or school there are many ways you can make a difference from letter writing to fundraising and habitat enhancement projects and more. To become an official Wetland Hero register at www.ducks.ca and describe the great conservation work you're doing to help protect wetlands. Wetland Heroes receive a certificate and a special token of appreciation from Ducks Unlimited Canada. With permission, selected Wetland Heroes may be featured online or in publications.

Habitat Enhancement

In some wetland areas, the surrounding habitat has already been degraded or lost and could benefit from the planting of wetland and waterfowl "friendly" plants. A number of aquatic plant species have the ability to remove large quantities of pollutants from water. These plants improve water condition by "uptaking" excessive amounts of nitrogen, phosphorous and carbon – substances associated with the occurrence of algal blooms – by storing them in plant tissues. Many "classic" beneficial plant species have limited distribution in Newfoundland, and should not be introduced to the sensitive ecosystem of the estuary without consideration of the potential consequences, including the possibility of invasive plants out-competing native plant species.

Often, the natural balance within an ecosystem can be changed when new species are introduced. The relationships that develop between plants and animals may also change within a particular habitat. Introduced species are referred to as "exotic" species if they are not native to an area. Competition naturally exists between organisms within an ecosystem but the introduction of exotic, or nonnative, species can alter the balance within the ecosystem and have negative effects upon the natural populations within the region and the ecosystem as a whole.

Eelgrass is an aquatic grass is known to have significant value for waterfowl and providing habitat for many aquatic species such as juvenile Salmonids. It is possible to encourage the growth of Eelgrass beds through an inexpensive project of habitat management and shoot transplantation from a nearby donor site. A thorough site evaluation would have to be initiated in consultation with staff of the Wildlife Division to assess the topography of the coastal area, water salinity and substrate suitability before proceeding with the project. However, encouraging eelgrass bed establishment is a project that has been successfully completed in a number of areas across Canada.

Certain species of Willow (*Salix discolor*) and Alder (*Alnus crispa*) are native to the island of Newfoundland, are found in areas of the Avalon Peninsula, and are renowned for their hardiness, their ability to withstand tidal inundation and their extensive network of roots (see Appendix 6 for a list of vegetative species that are ideal for bank stabilization). Their ability to uptake excess nutrients from the water column would make these native species an important addition to coastal shorelines. In addition to bank stabilizing properties and nutrient uptake characteristics, willow and alder buds and shoots are an important food source for small mammals like Muskrat (*Ondatra zibethicus*) and Snowshoe Hare (*Lepus americanus*), and bird species like Ruffed Grouse (*Bonasa umbellus*) and Grosbeaks (*Coccothraustes vespertinus*).

In terms of wetland plants that would be of dietary importance to waterfowl populations, Three-Square Bulrush (*Scirpus americanus*), Salt Water Cord Grass (*Spartina alterniflora*), Wild Rye (*Elymus virginicus*) and Blue-joint Grass (*Calamagrostis canadensis*) are all native to the island portion of Newfoundland and would all supply food to a number of estuary inhabitants. Tall stands of established Cord Grass and Wild Rye also offer a great deal of shade and cover to waterfowl and may lower water temperature to prevent algal blooms from occurring.

In terms of bank or shoreline stabilizing properties Blue-joint Grass and Dune Grass (*Ammophila breviligulata*) may be appropriate choices. Once established these grasses would provide a great deal of cover and concealment to waterfowl species. Low growing native shrubs may be interspersed with either grass species to enhance the desired effect of seclusion.

Litter Removal

It is strongly recommended that community interest groups and individual residents work cooperatively to remove the large quantity of litter in and around all portions of the community on a regular basis, while making certain to avoid those times of year (May to August) when waterfowl may be disturbed during breeding, staging or brood rearing periods. Programs such as Ocean Net and Vanaqua Shoreline Cleanup assist communities in organizing litter cleanups.

Water Control Structures

A community may wish to enhance a wetland area by changing the water flow or controlling the water depth (Figure 22) to attract waterfowl. Ducks Unlimited Canada (DUC), a partner of the Easter Habitat Joint Venture, has a great deal of experience in this area. Staff of the Wildlife Division can put you in touch with DUC to assess the possibilities, costs and issues in this area.



Figure 22 – Fish Baffles in Grand Falls – Windsor. Photo by: Charmaine Barney

APPENDICES

APPENDIX 1

STEWARDSHIP AGREEMENT

THIS AGREEMENT made at Gander, in the Province of Newfoundland and Labrador this 14th day of March, 2007.

BETWEEN: **HER MAJESTY THE QUEEN IN RIGHT
OF NEWFOUNDLAND AND LABRADOR,**
as represented by the Honourable the Minister
of Environment and Conservation

(hereinafter called the "Minister")

-of the one part-

AND: **THE TOWN COUNCIL OF THE TOWN OF GANDER**
a corporation pursuant to Section 15 of the *Municipalities Act*,
1999

(hereinafter called the "Town")

-of the other part-

WHEREAS the Government of Newfoundland and Labrador has entered into an Agreement with others for the implementation of the North American Waterfowl Management Plan through the Eastern Habitat Joint Venture;

AND WHEREAS the parties hereto recognize that the proper protection and management of both wetland and upland habitats are fundamental tools in maintaining and enhancing waterfowl populations in the province;

AND WHEREAS the Minister proposes that certain important wetlands and associated wildlife habitat within the Town be protected and enhanced through and with the cooperation of the Town in accordance with this Agreement and the Habitat Conservation Plan developed hereafter;

AND WHEREAS the Town has agreed to enter into the Agreement for the purpose of protecting and enhancing those areas of important wetland habitat within its jurisdiction.

NOW THEREFORE IT IS AGREED BY THE PARTIES HERETO AS FOLLOWS:

1. The lands herein delineated and designated as a Stewardship Zone (being the lands outlined on a certain Schedule annexed hereto and marked "A.") shall be managed in accordance with the terms and conditions of this Agreement including any Habitat Conservation Plan developed hereunder for better protection of the wetlands for waterfowl and other wildlife.
2. Within the Stewardship Zone, the Parties will establish Management Units as identified in Schedule "A" and other Management Units as may be desirable from time to time which shall be subject to the terms and conditions of a Habitat Conservation Plan designed to enhance and protect the wetland habitats, the waterfowl and other wildlife which use those habitats.
3. The Habitat Conservation Plan shall be developed in cooperation with the Town and the Minister agrees to provide such advice and expertise as may be necessary or advisable for the development of the Habitat Conservation Plan.
4. The Town agrees that in the preparation of a Municipal Plan for the Town or any amendments to any existing Municipal Plan, the areas designated as Management Units shall be recommended by the Town to be appropriately declared protected areas under subsection 13(3)(f) of the *Urban and Rural Planning Act, 2000* (or such other legislation in amendment or substitution therefore as may be brought into effect from time to time). The Town in passing regulations or by-laws related to the protected areas so designated under the Municipal Plan or amendments thereto and which may affect the Stewardship Zone shall do so in consultation with the Minister and in keeping with the principals of this Agreement.
5. The parties to this Agreement, their consultants, servants, or agents, shall have and exercise reasonable rights of access to the Stewardship Zone for all purposes necessary or incidental to this Agreement and in particular, but without limiting the generality of the foregoing, for the purpose of developing and carrying out the Habitat Conservation Plan.
6. Each of the parties hereto agree that they will exercise their best efforts to further develop management measures for more effectively carrying out of their mutual intentions as expressed in this Agreement.
7. If at any time during the term of this Stewardship Agreement the Parties deem it necessary or desirable to make any alterations or additions to it, they may do so by means of a written amendment between them which shall be supplemental to and form part of this agreement.

8. The parties hereto agree that this agreement shall remain in full force and effect for a period of (30) years computed from the date hereof and may be renewed at the termination of the initial (30) year period by mutual consent.

IN WITNESS WHEREOF the Parties have hereunto affixed their names by their proper signing officers duly authorized in that behalf, on the day and year first above written.

SIGNED SEALED AND DELIVERED

by the Honourable the Minister of
Environment and Conservation
in the presence of:



Witness



**THE HONOURABLE THE MINISTER
OF ENVIRONMENT AND
CONSERVATION**

THE SEAL OF the Town Council of the
Town of Gander hereunto affixed in the
presence of:

**THE TOWN COUNCIL OF THE TOWN OF
GANDER**
Witness:  Signature: 
I/We have the authority to bind the corporation
Name: CLAUDE ELLIOTT
Title: MAYOR

**THE TOWN COUNCIL OF THE TOWN OF
GANDER**
Witness:  Signature: 
I/We have the authority to bind the corporation
Name: GARY BROWN
Title: TOWN CLERK

APPENDIX 2 – SCHEDULE “A”

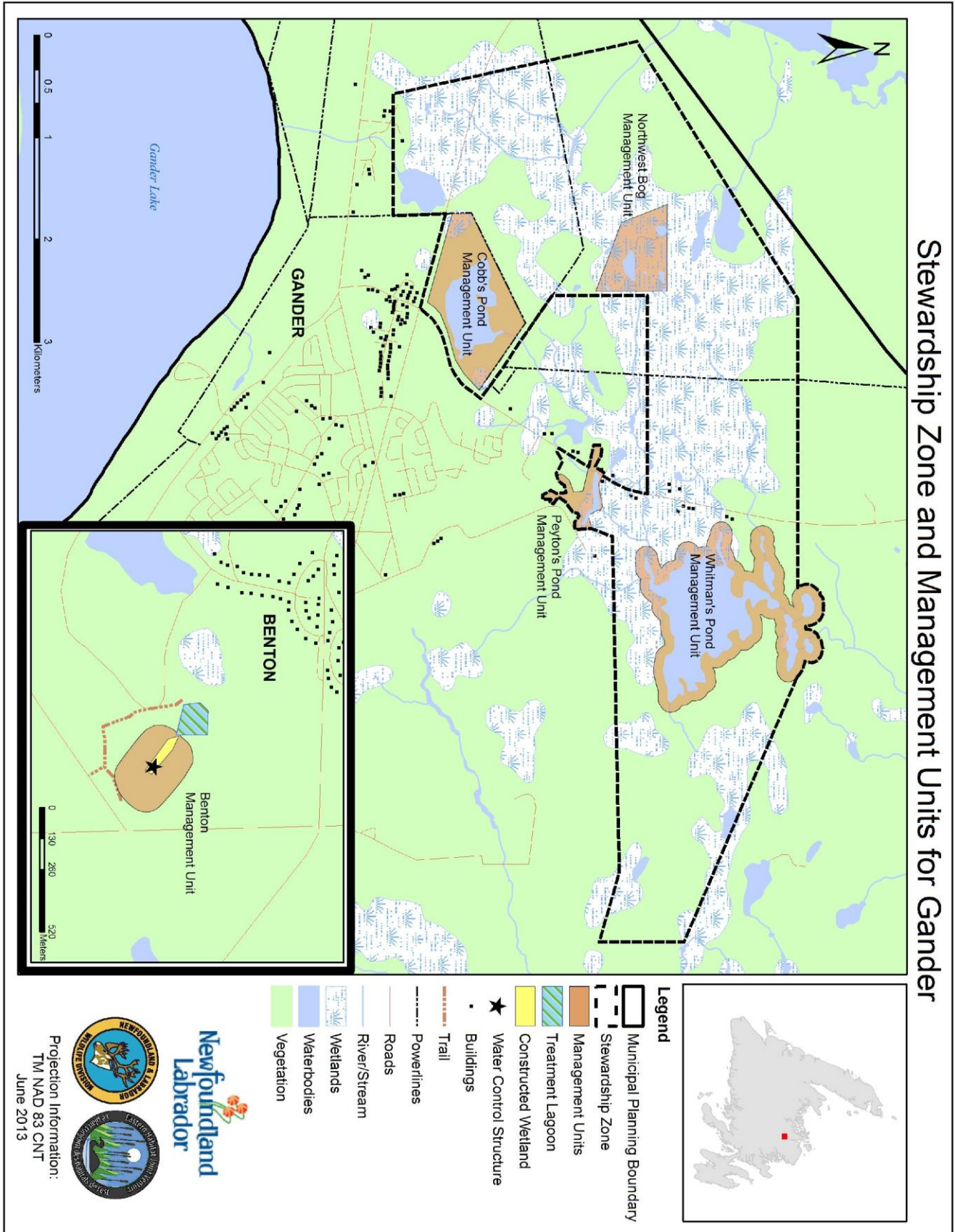

APPENDIX 3

Waterfowl Monitoring Project Protocols and Data Sheet

Generally within a community's wetland management units, a set number of locations for viewing waterfowl are chosen and outlined on a detailed map. These sites are chosen, for ease of access and ability to view waterfowl over a wide area, but they are also relatively evenly distributed around the wetland. Sites can be chosen to sample productive, historically productive and potentially non-productive waterfowl locations to give a representative snapshot of inhabitants of the estuary.

Each site location should be visited during a single day, within a two-three hour period, which will mean, in most towns, that more than one person will need to be involved. The survey should occur, at least once within a two week period in both the spring and fall. You are most welcome to complete and record as many observations as your schedules permit but the above indicates that, at a minimum, at least two surveys would occur annually.

These surveys should occur **during the last two weeks of June and during the first two weeks of October and should occur either in the early morning (starting at dawn and up to ~ 3 hours afterwards) or in the early evening (starting ~3 hours before dusk).**

If you are not already familiar with the area it would be advantageous for you to become familiar with the sample locations identified on the map prior to the day of your survey. It may also be prudent to seek private landowner permission in advance of your intended survey day. In addition, identify access points (ex. determine whether best approached by foot or by boat) well in advance so that your survey can be completed in a single morning or evening.

Survey Locations

The intended survey sites should be relatively easy to access (off roads or meadows) and are intended to follow the shoreline of the wetland. **Observations should be made within a semi-circle** oriented towards the wetland instead of attempting to watch in a full circle all around you which could form an unnecessarily difficult amount of survey area in a short period. Orient yourself so that you can maximize the amount of wetland being observed (i.e. your view should not encompass a large swath of open field or roadway) **out to a distance of ~100m on either side of you.** It may be prudent to become familiar with what a 100m distance roughly looks like before setting up your survey.

Some sites may be more easily accessed by non-motorized water craft such as canoe or kayak. If you choose to use canoe or kayak, the centre of the semicircle will become your boat and you will orient your semicircle accordingly. It will be

especially important to approach your survey site slowly and quietly by boat or kayak since your odds of flushing waterfowl will be increased.

Consider the following drawing as your sample area:

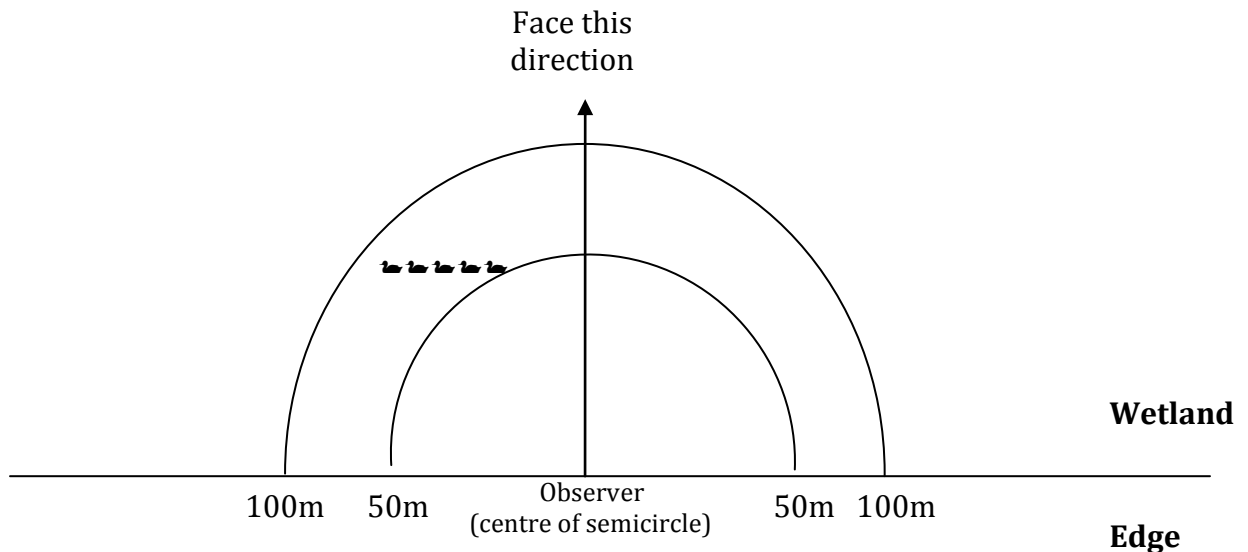

Tools you should consider having include the following:

- A keen eye!
- Field notebook or data sheet (attached)
- Pencil - record findings
- Watch - keep track of time (10 minutes per survey site)
- Bird field guide
- Pair of binoculars and/or a spotting scope (binoculars may be sufficient)
- Appropriate outdoor clothing
- Cellular phone in case of an emergency

Conducting the Survey

Surveys should only be conducted under suitable or good weather conditions. This includes good visibility out to 100m, reasonably warm air temperature, little or no precipitation and little or no wind. If poor conditions develop and last for an extended period, it is suggested that you reschedule your survey for another day. **Once you have reached the survey site and oriented yourself so that you have maximal view of the area, sit quietly and begin timing for 10 minutes.** It is advised that you record any waterfowl that may be flushed out of the sample area during your approach and/or set up period in the space provided at the bottom of your record sheet, indicating that waterfowl left the area just prior to the survey.

Record all waterfowl species seen within the survey area during the 10minute period. If possible distinguish between male and female adults where possible and the numbers seen (including individual ducklings making up broods) in the appropriate space on the attached record sheet. Use a separate column for each sample site, identifying the site # at the top of the column. Also note any ducks that fly over, through, or out of, your sample area at the bottom of the reporting sheet.

Do not guess! It is entirely acceptable to record a species as unknown. You should be certain of the identity of a species before recording it. Birding workshops and informal bird watching excursions in your local area will make you proficient at identifying species common to your area in no time! If you find that you are recording several unknowns....that is perfectly acceptable. As years go by, you will become more and more adept at identification.

Additional Information to Record

If you are able to identify other, non-waterfowl, species of birds either by call or site in the vicinity of your survey area, please enter those in the space provided at the bottom of the appropriate column on the reporting sheets.

Excessive disturbance or noise from a number of sources (people talking, vehicles, farm equipment, boat traffic, etc.) could influence the behavior and movement of waterfowl that you are monitoring. Please take time to record any type of disturbance at the bottom of your reporting sheet (under the appropriate column corresponding to your survey site).

General / Safety Considerations

It is important to be mindful of the tides and the wetland (damp, soft, slippery) habitat that you may be asked to survey near, making personal safety your top priority. Further, if survey locations fall on private property, first seek permission from the land owner to access the property.

It is important throughout your survey that you aim to cause as little disturbance as possible to the birds that you are viewing, considering that many ducks will either be raising broods at the time of your survey or preparing for long migrations and a high level of disturbance could mean an impact on waterfowl foraging. If you approach an area and it seems to be causing a hen to separate from her ducklings, leave the area. If you approach an area and an adult seems at all aggressive (i.e. Canada goose hissing), leave the area. Common sense is important; don't put yourself or the birds that you are watching in jeopardy.

Finally, **have fun!** The intent behind this survey is to have an enjoyable community waterfowl-monitoring effort. **Not every person has to commit to monitoring all of the same survey locations every year**, but your birding group may find it more

manageable to have the same person (or group) monitor the same few sample locations year after year. If certain people in your community live close to certain survey sites, have special knowledge of certain sample sites or have a strong desire to sample certain sites year after year.....feel free to organize your survey group accordingly. Similarly, if you would like to rotate the groups of sites making up your larger survey area amongst your birding group that is acceptable, as long as the non-productive sites are factored into how you distribute the sites amongst volunteers.

What Will Happen to The Data?

Each year data sheets will be returned to EHJV staff who will compile the information to maintain a database on the diversity and abundance of waterfowl usage of the wetlands in question. This information is available on request but summary results will be forwarded to participants each year to keep you up to date on how your wetland and waterfowl are doing.

Feedback

We would appreciate learning more about any problems that you might have encountered with this protocol and would welcome any suggestions for improvement. The Eastern Habitat Joint Venture can be contacted anytime.

The Completed Survey Sheets Should Be Returned To:

NL Eastern Habitat Joint Venture
Wildlife Division - Department of Environment and Conservation
P.O. Box 2007 • 117 Riverside Drive
Corner Brook, NL • A2H 7S1
(709) 637-2006

APPENDIX 4

Wildlife Species Found in the Gander Stewardship Zone

<u>COMMON NAME</u>	<u>SCIENTIFIC NAME</u>
<u>Dabbling Ducks:</u>	
American black duck	<i>Anas rubripes</i>
Green-winged teal	<i>Anas crecca</i>
<u>Diving Ducks:</u>	
Ring-necked duck	<i>Aythya collaris</i>
Common goldeneye	<i>Bucephala clangula</i>
<u>Loons:</u>	
Common loon	<i>Gavia immer</i>
<u>Wading Birds:</u>	
American bittern	<i>Botaurus lentiginosus</i>
Wilson's snipe	<i>Gallinago delicata</i>
Spotted sandpiper	<i>Actitis macularia</i>
Least sandpiper	<i>Calidris minutilla</i>
Solitary sandpiper	<i>Tringa solitaria</i>
Greater yellowlegs	<i>Tringa melanoleuca</i>
<u>Gulls:</u>	
Ring-billed gull	<i>Larus delawarensis</i>
Great black-backed gull	<i>Larus marinus</i>
Herring gull	<i>Larus argentatus</i>
<u>Raptors:</u>	
Northern harrier	<i>Circus cyaneus</i>
Osprey	<i>Pandion haliaetus</i>
Short-eared owl	<i>Asio flammeus</i>
<u>Non-Passerine Land Birds:</u>	
Downy woodpecker	<i>Picoides pubescens</i>
Belted kingfisher	<i>Ceryle alcyon</i>
<u>Passerine Birds:</u>	
White-throated sparrow	<i>Zonotrichia albicollis</i>
American robin	<i>Turdus migratorius</i>
Swamp sparrow	<i>Melospiza georgiana</i>
Fox sparrow	<i>Passerella iliaca</i>
Song sparrow	<i>Melospiza melodia</i>
American tree sparrow	<i>Spizella arborea</i>

Grey jay
Black-capped chickadee
Boreal chickadee
Yellow-rumped warbler
Palm warbler
Rusty blackbird
Swainson's thrush
Hermit thrush
Northern waterthrush
Ruby-crowned kinglet
Cedar waxwing
Dark-eyed junco
Pine siskin
American crow
Common raven

Mammals:

Moose
Black bear
Snowshoe hare
Beaver
Otter
Muskrat

Perisoreus canadensis
Poecile atricapilla
Poecile hudsonica
Dendroica coronata
Dendroica palmarum
Euphagus carolinus
Catharus ustulatus
Catharus guttatus
Seiurus noveboracensis
Regulus calendula
Bombycilla cedrorum
Junco hyemalis
Carduelis pinus
Corvus brachyrhynchos
Corvus corax

Alces alces
Ursus americanus
Lepus americanus
Castor canadensis
Lontra canadensis
Ondatra zibethicus

APPENDIX 5

Trail Entrance Interpretative Sign, Steady Brook

WELCOME TO STEADY BROOK'S MUNICIPAL HABITAT Stewardship Areas

Two Management Units within the Town of Steady Brook cover approximately 27 acres of wetland habitat and include the mouth of Steady Brook and its adjacent cattail marsh, as well as a small marsh near the eastern end of the town's boundaries.

The Town of Steady Brook and the Government of Newfoundland and Labrador signed a Municipal Habitat Stewardship Agreement in July 2011, committing to the conservation and enhancement of wildlife habitat within the town's planning boundaries.



The Town of Steady Brook is a leader in wildlife conservation in a chain of committed partners across North America. In eastern Canada, this partnership is known as the Eastern Habitat Joint Venture (EHJV).





Explore Steady Brook's wildlife diversity

Waterfowl

- American Black Duck (*Anas rubripes*)
- American Goldeneye (*Bucephala clangula*)
- Common Goldeneye (*Bucephala clangula*)
- Common Merganser (*Mergus merganser*)
- Ring-necked Duck (*Aythya collaris*)
- Common Loon (*Gavia immer*)

Songbirds

- American goldfinch (*Carduelis tristis*)
- Cedar Waxwing (*Bombycilla cedrorum*)
- Song Sparrow (*Melospiza melodia*)
- Tree Swallow (*Icthyophaga bicolor*)
- Pine Siskin (*Carduelis pinus*)
- Dark-eyed Junco (*Junco hyemalis*)
- Black and White Warbler (*Anthodia vana*)
- Blue Jay (*Cyanocitta cristata*)
- American Robin (*Turdus migratorius*)

Other bird species:

- Belted Kingfisher (*Megascops asio*)
- Red-winged Blackbird (*Aegialitis phoeniceus*)
- Common Grackle (*Quiscalus quiscula*)
- Common Raven (*Corvus corax*)
- Crow (*Corvus brachyrhynchos*)
- American Osprey (*Pandion haliaetus*)
- American Osprey (*Pandion haliaetus*)

Other wildlife species:

- Beaver (*Castor canadensis*)
- Muskrat (*Fiber zibethicus*)
- Mink (*Mustela vison*)
- Snowshoe Hare (*Lepus americanus*)
- Atlantic Salmon (*Salmo salar*)
- Brook Trout (*Salvelinus fontinalis*)
- American Eel (*Anguilla rostrata*)



Mouth of Steady Brook and Adjacent Cattail Marsh:

Located where Steady Brook joins with the Humber River and is comprised of shallow channels of open water surrounded by overhanging shrubs, primarily Sweet Gale (*Myrica gale*).

The adjacent marsh contains a large quantity of shallow, open water separated by a patchwork of emergent vegetation such as Cattail (*Typha latifolia*), which dominates the area.

Grasses, such as Reed Canary Grass (*Phalaris arundinacea*) and Rushes (*Juncus* sp.), provide suitable feeding and nesting habitat for many waterfowl species.

Marsh at the Eastern Boundary of Steady Brook:

Located along the edge of the Humber River at the eastern end of the town and also contains habitat suitable for nesting and staging waterfowl and other wildlife species. This area is located on private property and is not accessible by land.

The marsh is partially inundated and dominated by tall emergent grasses, rushes, sedges and other herbs and shrubs such as Blue Flag Iris (*Iris versicolor*), Horsetail (*Equisetum* sp.) and Sweet Gale (*Myrica gale*). Adjacent upland habitat surrounding this wetland consists primarily of mixed boreal forest.



CONTACT:

Department of Planning, Municipal Affairs, Water, Conservation and Smart Growth
 Municipality of Steady Brook, 300 Main Street, Steady Brook, NL A1A 1A1
 Phone: 709-339-7500, Fax: 709-339-7501, Email: info@steadybrook.ca





APPENDIX 6

Artificial Nesting and Loafing Structures Osprey Platforms (Courtesy of Government of Ontario)

EXTENSION NOTES



BUILDING NESTING PLATFORMS FOR OSPREYS

Although they were once scarce in Ontario, ospreys have made a striking comeback in recent years. Thanks to concerned people working together to build and install special nesting platforms, these large brown and white fish hawks are now a familiar sight along many waterways.

This Extension Note provides information on how to construct and install two types of nesting structures — the single-poled platform and the quadropod platform.

THE OSPREY STORY

Ospreys are found across Canada and in most parts of the world. In Ontario, they nest in regions as far north as Algonquin Park.

During the 1950s and '60s, osprey populations dropped dramatically in the province. Pollutants, such as the insecticide DDT, had contaminated many waterways and were accumulating in fish. Because fish are an important source of food for ospreys, they too were affected. Fortunately, the use of DDT was banned in Ontario in 1974.

Today, ospreys are returning, but only to face another obstacle. Ospreys generally build their nests in tall, isolated trees that are close to shallow bodies of water. During their 20-year absence, many of these natural nesting sites were destroyed, forcing some ospreys to nest on hazardous structures such as hydro poles and television towers.

For the past few years, the Ministry of Natural Resources, along with groups of concerned citizens from Georgian Bay to the St. Lawrence River, have embarked on a campaign to build nesting structures specially designed for ospreys.

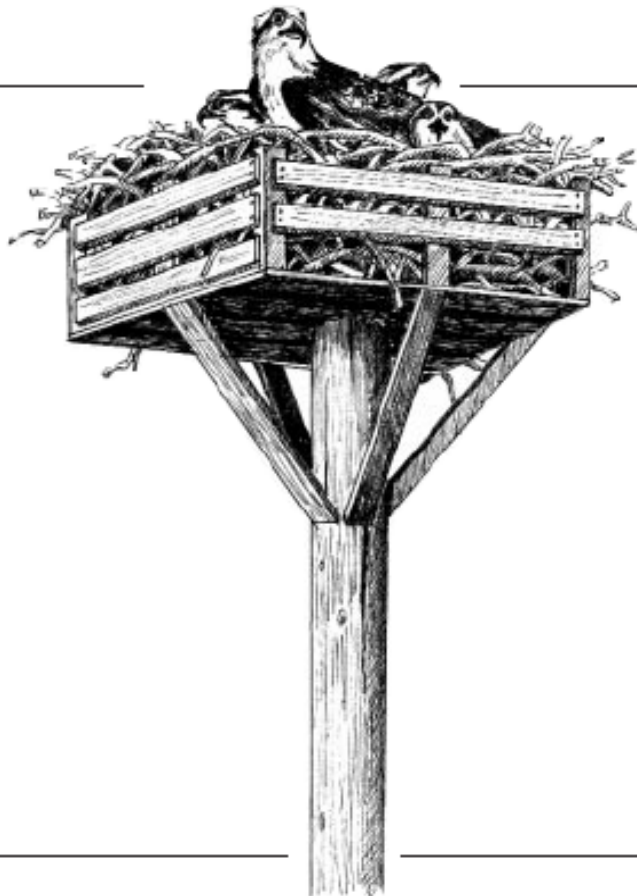

BEFORE YOU START

Erecting platforms in lakes and rivers may require a permit. Before you begin, contact the Ministry of Natural Resources for more information. Other agencies, such as

Parks Canada and local conservation authorities, may also have to be informed.

NESTING PLATFORMS

There are different types of nesting platforms for different site conditions. The quadropod is designed to be placed directly in the water, while the single-poled structure is designed for use on land.

When choosing a site for a nesting platform, consider the following:

- Ospreys feed almost exclusively on fish. Sites should be no more than three kilometres from shallow bodies of water — 50 metres is ideal.

- Platforms should be erected in open areas, giving the osprey room to build a nest as well as to protect it from predators, such as raccoons and owls.
- Sites should be sheltered from prevailing winds and major ice movement. They should also be at least 100 metres from human activity.
- When building several nesting platforms on one site, they should be placed at least 300 metres apart.

THE QUADROPOD PLATFORM

As the name implies, this platform has a four-legged base. Because it's left in the water year-round, it's important to choose a location where it won't be a hazard to boaters, and where winter ice won't disrupt it. Good locations include quiet bays or isolated marshes.

Install the quadropod during winter months when ice conditions make it easier to get around. You'll need three or four people to carry equipment, position poles and erect the platform.

EQUIPMENT

- four cedar poles, six metres in length (sharpen thick end)
- 1.2 by 1.2 metre skid or pallet
- eight-inch auger
- 2 eight-inch spikes
- 30 two-inch roofing nails
- 12 four-inch spiral spikes/nails
- 12 six-inch spiral spikes/nails
- six metres of black fencing wire
- pliers, claw hammer, sledge hammer, saw and ice pick
- four pieces of one-metre-square sheet metal or children's plastic roll-up toboggans for predator guards
- 1.2 metres of chain
- hardwood block (about 10 x 10 x 25 centimetres)
- five-metre ladder

Quadropod platforms are designed for use in water. Quiet bays and marshes are ideal locations.

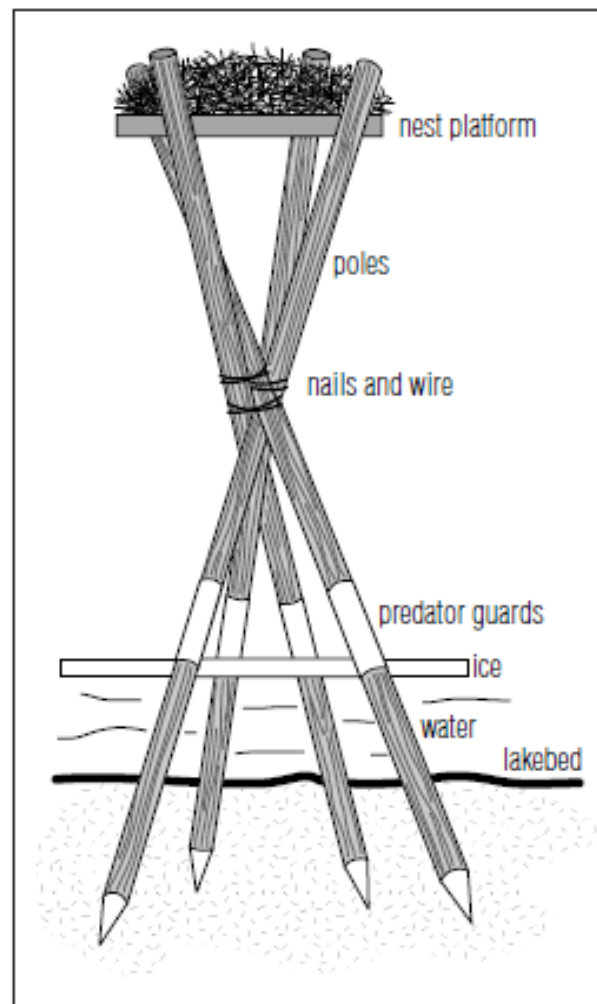

**BUILDING NESTING
PLATFORMS FOR
OSPREY**
INSTALLATION

Follow these steps to install the quadropod platform.

1. Drill four holes into the ice at a 45 degree angle. The holes should be approximately two metres apart, forming a square.
2. Ram the sharpened poles down into the ice holes and then use the sledge hammer to knock them at least one metre into the ground below the ice. To make the job of hammering easier, attach the block of hardwood to the side of each pole using a length of chain. To hold the chain in position, notch a small V into the pole using the saw (see Figure 1).
3. Place the wood pallet or skid in a level position between the tops of the poles. The platform should be at least 2.4 metres above the ice. Using the six-inch spikes, nail and wire the platform to the poles.
4. Wire and nail the poles together using the eight-inch spikes where they cross near the centre of the structure.
5. Wrap the predator guards (sheet metal or plastic toboggans) around each leg of the structure. Nail

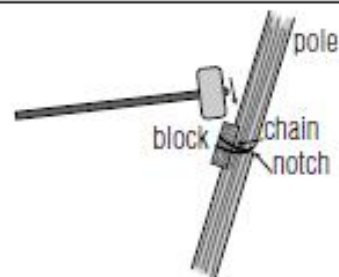

Figure 1

them in place with roofing nails, ensuring that they are pounded in flush and can't provide toe-holds for predators.

6. Wire a few "starter" sticks onto the bottom of the platform to attract an osprey. An extra perch can be installed off to the side or above the platform. This provides a place for the male to roost during the nesting season.

SINGLE-POLED PLATFORM

The single-poled platform is better suited for use on land. It's adaptable to areas with deep soil, as well as areas with no soil. Your first challenge may be to find a long and sturdy pole. Old hydro poles are ideal. Try contacting your local utility company or Bell Canada office to inquire about obtaining poles for this purpose.

EQUIPMENT

- one pole, six to nine metres in length
- 1.2 by 1.2 metre skid or pallet with 10-inch high retaining fence
- four wood or metal braces
- power auger (for deep soil sites)
- rock drill and mounting set (for rocky sites)



The single-poled platform is designed for use on land. It can be erected in deep soil or on rock.

**BUILDING NESTING
PLATFORMS FOR
OSPREY**

- six-inch spikes
- two-inch roofing nails
- steel guy wire
- four eye bolts (minimum two-inch thread)
- cement
- pliers, claw hammer and sledge hammer
- one piece of one-metre square sheet metal or children's plastic roll-up toboggans

DEEP SOIL

Follow these steps to install a single-poled platform in deep soil:

1. Attach the nesting platform (skid or pallet) to the pole. Wire a few "starter" sticks to the platform.
2. Use the power auger to drill a hole one to two metres deep.
3. Place the pole in the hole and secure it with cement, sand or rock.
4. If necessary, attach guy wires to add extra support.
5. Wrap the predator guards (sheet metal or roll-up toboggans) around the pole. Nail them in place with roofing nails, ensuring that they are pounded in flush and can't provide toe-holds for predators.

ROCK

While a little more involved, it is still easy to erect nesting poles in rocky areas. The most difficult piece of equipment to come across may be the rock drill and mounting sets used by utility companies. Follow

these steps to install a single-poled platform on rock.

1. Attach the nesting platform (skid or pallet) to the pole. Wire a few starter sticks to the platform.
2. Use the rock drill to make the holes to accommodate the mounting set.
3. Set the bracket inside the holes. Pour in cement for additional support.
4. Raise and anchor the pole in place using the mounting set.
5. If necessary, attach guy wires prior to raising the pole to add extra support.
6. Wrap the predator guards (sheet metal) around the pole. Nail them in place with roofing nails, ensuring that they are pounded in flush and can't provide toe-holds for predators.

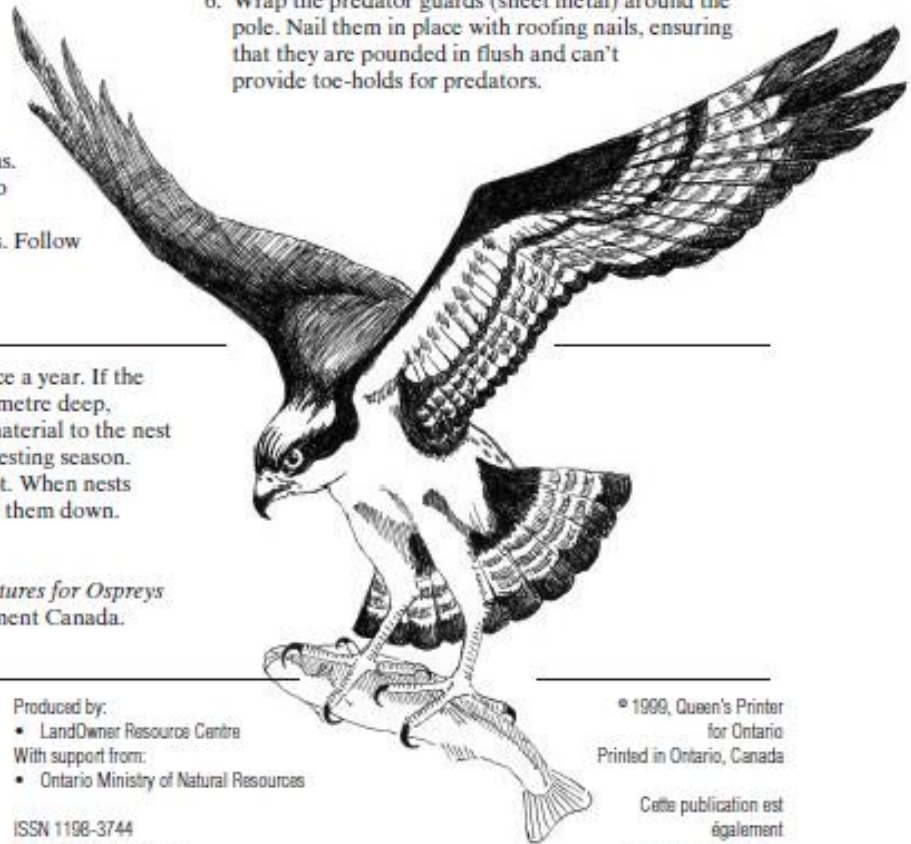

The pole is anchored with a mounting set.

MAINTENANCE

Inspect the nesting platform at least once a year. If the material in the nest is more than half a metre deep, remove a layer of sticks. Ospreys add material to the nest at the beginning and at the end of the nesting season. Although nests look sturdy, they are not. When nests become too large, windstorms can blow them down.

Further reading:

- Ewins, P.J. 1994. *Artificial Nest Structures for Ospreys — A Construction Manual*. Environment Canada. Toronto, Ontario. 41p.

For more information contact:

LandOwner Resource Centre
P.O. Box 599, 5524 Dickinson Street
Manotick, Ontario K4M 1A5
Tel 613 692 2390 or 1 800 387 5304
Fax 613 692 2806
E-mail: lro@sympatico.ca

Product Ordering: 1 888 571 INFO (4636)
Internet: <http://www3.sympatico.ca/lro>

Produced by:

- LandOwner Resource Centre
- With support from:
- Ontario Ministry of Natural Resources

ISSN 1198-3744
R.P. (5¢ P.R., 99 02 11)

© 1999, Queen's Printer
for Ontario
Printed in Ontario, Canada

Cette publication est
également
disponible en français.

♻️ printed on recycled paper

Bird House Dimension and Placement
(Courtesy of Ohio's Division of Wildlife – Wildlife Diversity and Endangered Species Program)

Species	Specifications					
	Inches				Feet Above Ground	Preferred Habitat
	Entrance		Floor Dimensions	House Depth		
	Diameter	Above Floor				
Bluebird	1 ½	6-7	5 x 5	8-9	5-10	Open field with perches
Chickadee, black capped	1 ½	6-8	4 x 4	8-10	5-15	Woodland with perches
* Carolina	1 ½	6-8	4 x 4	8-10	6-15	Woodland
Flicker	2 ½	14-16	7 x 7	16-18	6-20	Woodland
Fly catcher, great crested	2	6-8	6 x 6	8-10	8-20	Woodland
Kestrel	3	9-12	8 x 8	12-15	10-30	Open field
Martin, purple	2 ½*	18	6 X 6*	6*	15-20	Open fields AWAY from trees & near water
Nuthatch, white-breasted	1 ¼	6-8	4 x 4	8-10	12-20	Woodland
Owl, barred	7 x 7 arch	12	12 x 12	23	20-23	Woodland
* screech-	3	9-12	8 x 8	12-15	10-30	
* barn	6 x 6	6	12 x 36	15-18	20-25	
Phoebe	Open front & sides		7 x 7	8	8-12	Backyard
Robin	Open front & sides		7 x 7	8	8-12	Backyard
Swallow, tree	1 ½	1-5	5 x 5	6	6-10	Open field near water
Titmouse, tufted	1 ¼	6-8	4 x 4	8-10	6-15	Woodland edge & interior
Warbler, prothonotary	1 ½	6	5 x 5	8	5-10	Over and near water
Woodpecker, downy	1 ¼	6-8	4 x 4	8-10	6-20	Woodland interior
* hairy	1 ½	9-12	6 x 6	12-15	12-20	
* red-bellied	2 ½	10-12	6 x 6	12-14	12-20	
* red-headed	2	9-12	6 x 6	12-15	12-20	
Wren, Carolina	1 ½	4-6	4 x 4	6-8	5-10	Near brushy areas & backyards
* house	1 ¼	4-6	4 x 4	6-8	5-10	

*These are the dimensions for one compartment. Martins nest in colonies; therefore, martin houses should have a minimum of six self-contained apartments.

Removing unwanted species such as starlings and house sparrows will increase your chances for nesting success.

AMERICAN KESTREL, EASTERN SCREECH-OWL NEST BOX



Preferred habitat for owls includes mixed stands of deciduous forest on the edge of woods adjacent to fields or wetlands. Kestrels prefer more open country. To prevent use by squirrels, the box for owls can be placed on a pole with a predator guard. Boxes should be placed at least 10 feet high for owls, and 10 to 30 feet high for kestrels

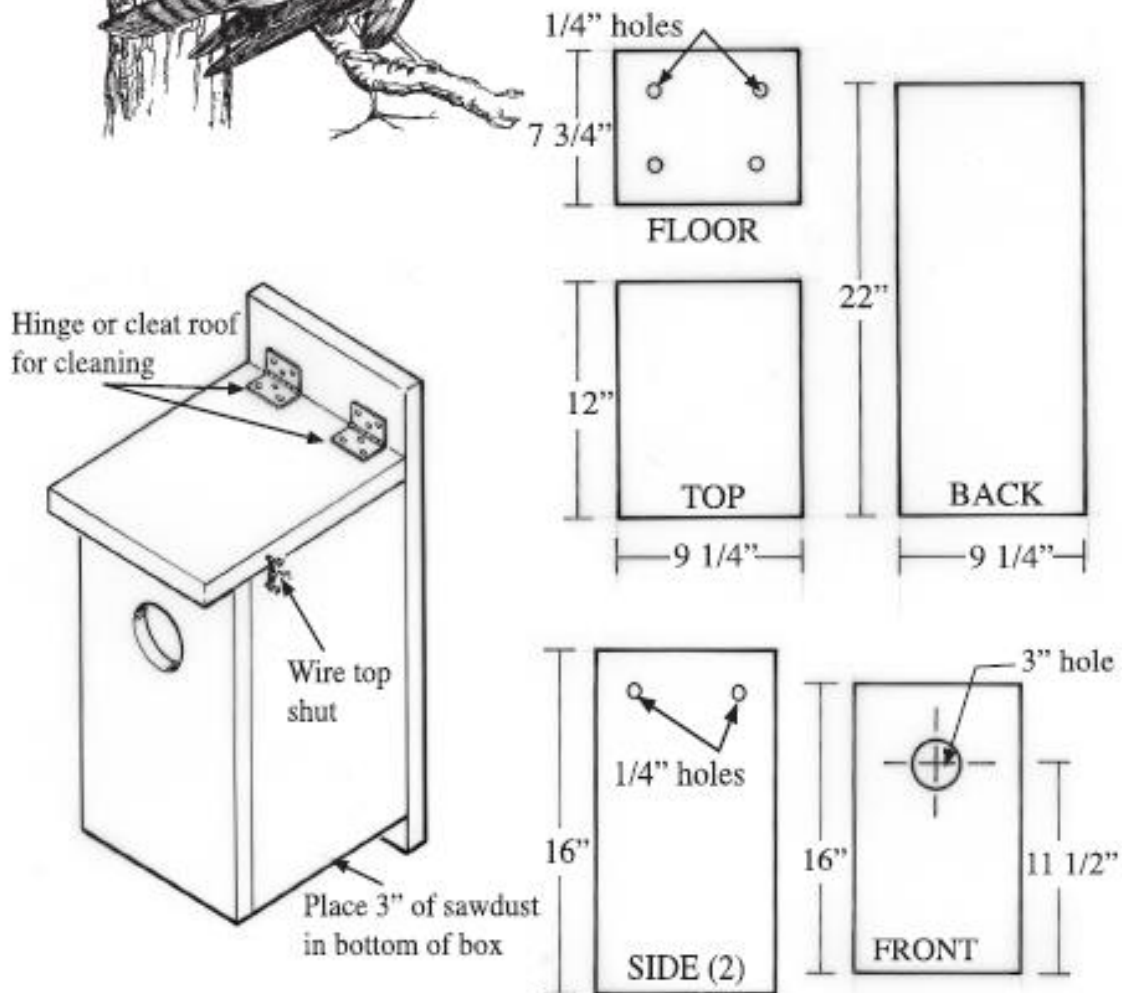

LUMBER: One 1" x 10" x 8'0"

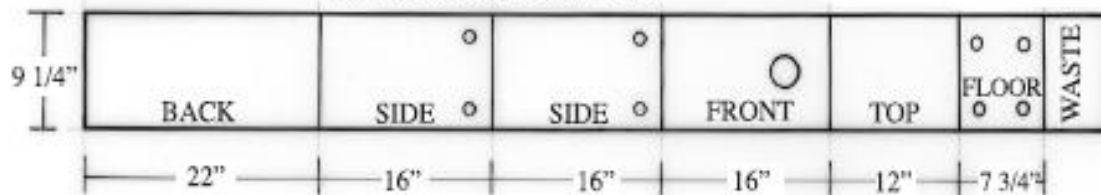

WOOD DUCK NEST BOX



Boxes placed on posts in water should be six to eight feet above the water. Wood duck boxes can also be placed in woodland habitat up to a half mile from lakes, ponds, marshes, and rivers. Since the hen must lead her ducklings to water after they hatch, the habitat between the house location and the water's edge should be free of major obstacles, such as fences, highways, mesh wire, or curbing.

Cavity nesting ducks do not carry nesting materials. It is important to help them out by placing 2-4 inches of wood shavings (not sawdust) in the bottom of the box. Also, some type of predator guard should be used.

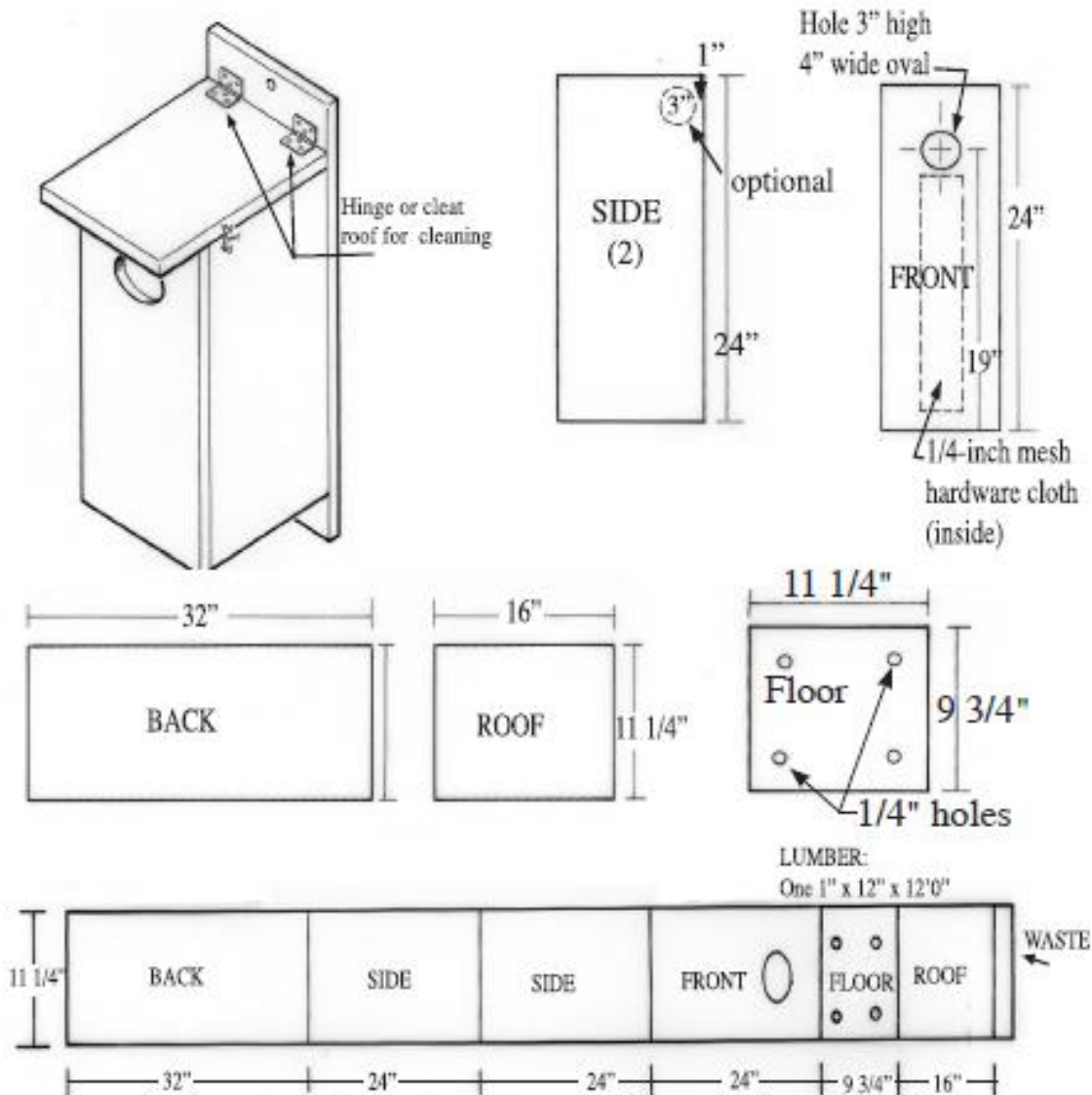

EASTERN BLUEBIRD, TREE SWALLOW NEST BOX

Ideal bluebird habitat is mixed hardwood forest and grasslands. The grassy areas may be meadows, pastures, yards, cemeteries, highway rights-of-way, or prairies. The most desirable grass for bluebirds and tree swallows is short or sparse, mowed or grazed. The area must also provide enough feeding perches. There can be power lines, fence posts, or scattered trees. Boxes should be mounted on posts, about five feet above ground.

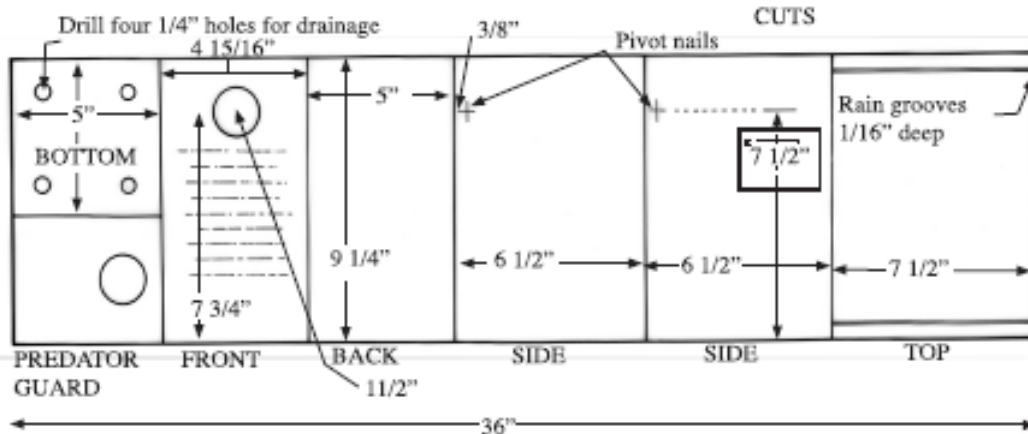
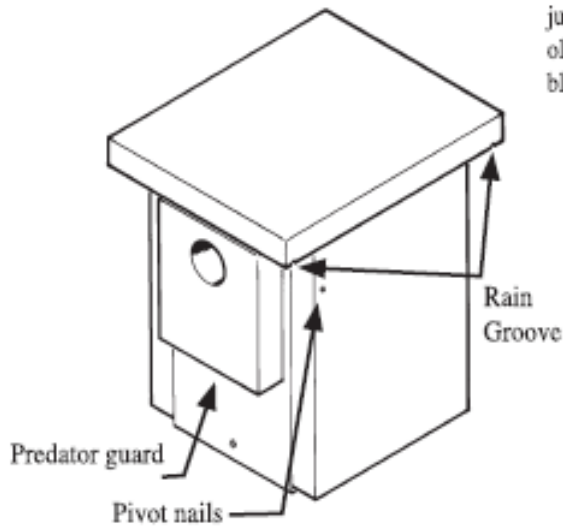
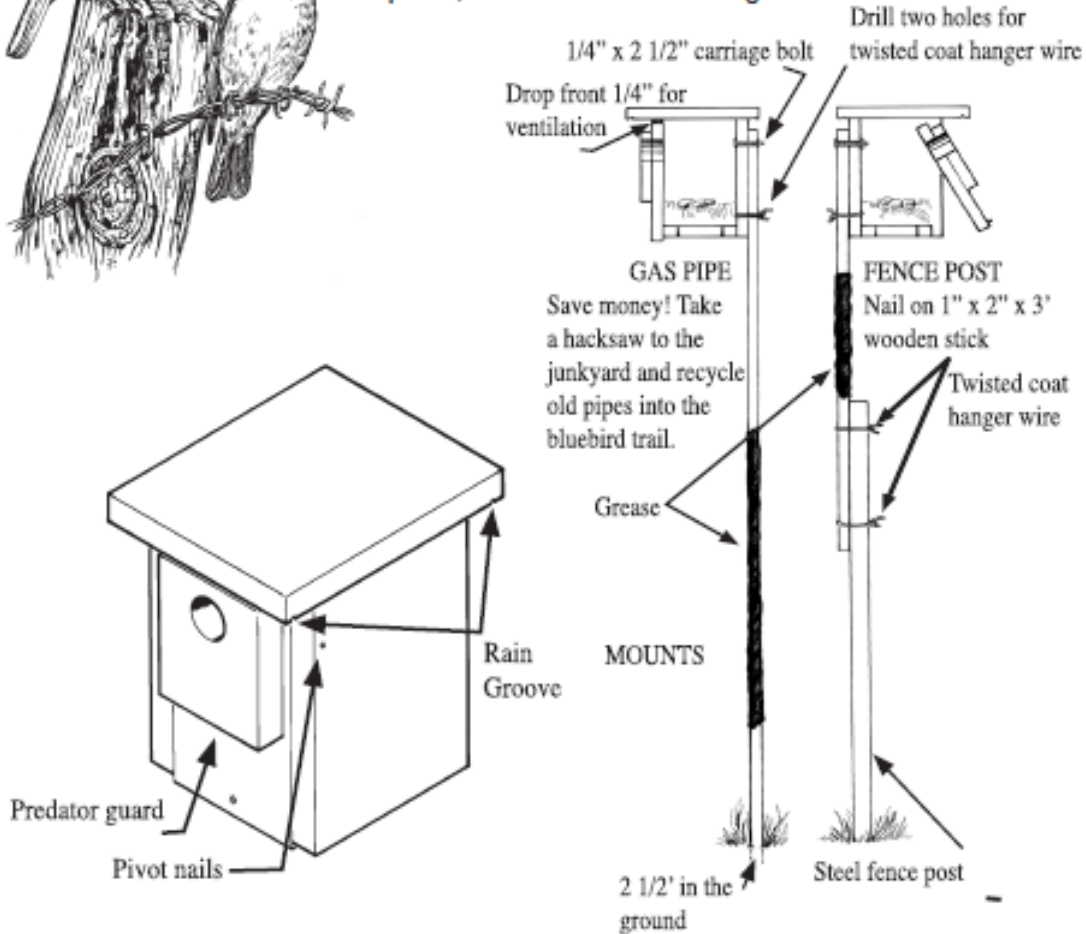

Box Roosting Boxes

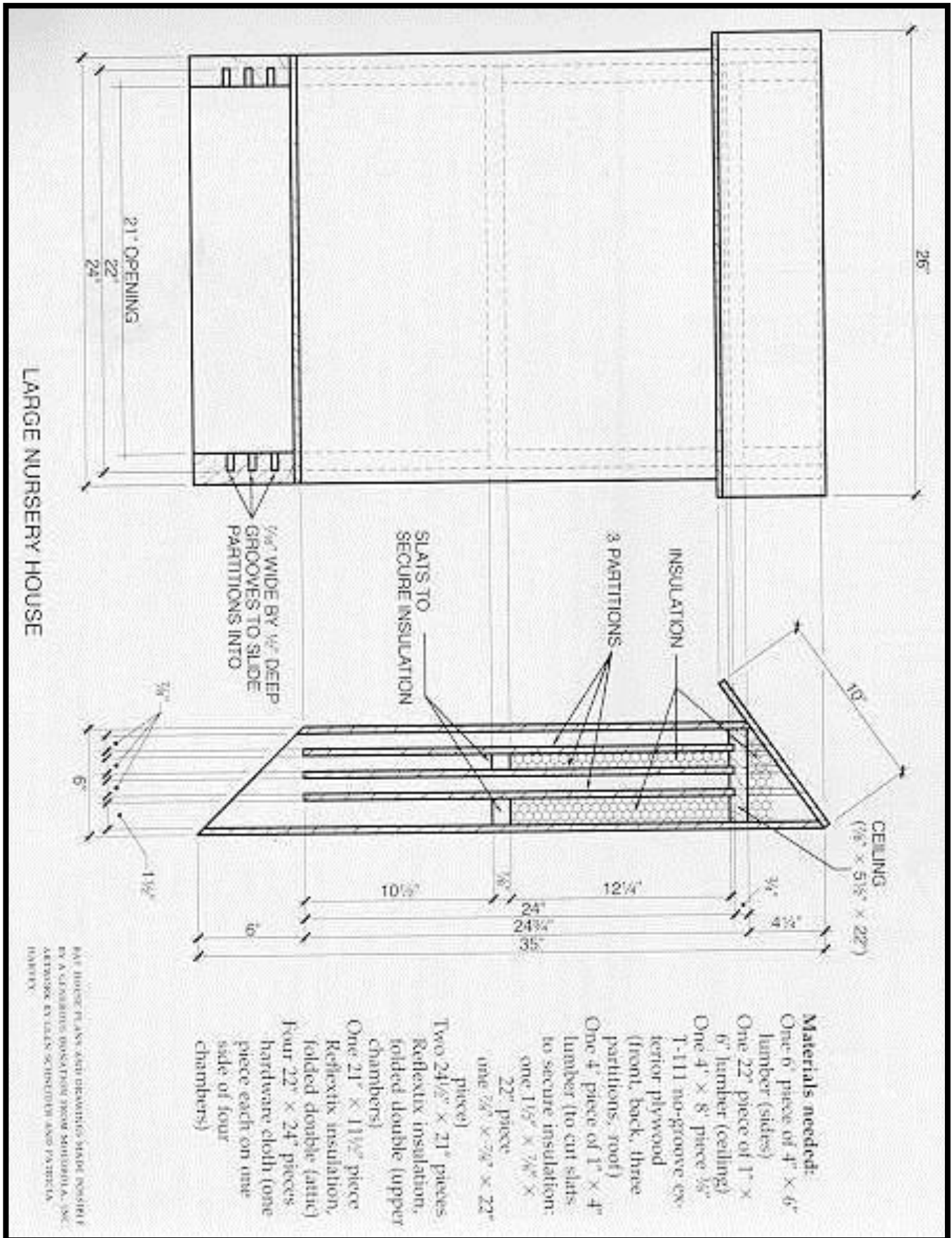

**Bat Box in Pynn's Brook, Western Newfoundland. Photo by:
Wildlife Division Staff**



APPENDIX 7 Shoreline Planting Chart

Species	Range	Site Requirements	Conservation Value
Shrubs and Small Trees			
American mountain ash	Coast to coast	Full sun; wide range of soils	Vegetation buffer; wildlife food, cover, and nesting sites
Balsam-poplar	Coast to coast	Full sun to partial shade; prefers most soils on shorelines	Erosion control; vegetation buffer; wildlife food, cover, and nesting sites
Blackberry	Coast to coast	Moist, well-drained soils	Vegetation buffer; fence row; food and cover for birds and mammals; butterfly nectar source
Elderberry	Coast to coast	Full sun to full shade; rich, moist soils	Food and cover for shoreline birds and mammals; butterfly nectar source
Highbush cranberry	Alta., Sask., Man., Ont., Que., N.B., N.S., P.E.I., Nfld.	Stream banks and lake shores; wide range of soils; shade tolerant	Erosion control; vegetation buffer; fence row; food for birds and mammals
Pussy-willow	Coast to coast	Full sun; deep, rich shoreline soils; moist to wet conditions	Vegetation buffer; fence row; nectar source for pollinators
Raspberry	Y.T., N.W.T., B.C., Ont., Que., N.B., N.S., P.E.I., Nfld.	Wide range of soils; shade tolerant; flood tolerant; stream banks and lake shores	Erosion control; vegetation buffer; fence row; food and shelter for birds and mammals
Red-osier dogwood	Coast to coast	Full sun to partial shade in moist to wet soils; stream banks; lake shores; wetlands	Vegetation buffer; fence row; food, cover, and nesting sites for birds and mammals
Wild black currant	Y.T., N.W.T., Alta., Sask., Man., Ont., Que., N.B., N.S.,	Wide range of soils; moist to wet shorelines	Erosion control; vegetation buffer; fence row; wildlife

	P.E.I., Nfld.		food and cover; butterfly nectar source
Trees			
Ash	Coast to coast	Alongside stream banks and lake shores; wet sites alongside wetlands; full sun to partial shade	Erosion control; vegetation buffer; fence row; wildlife food, cover, and nesting sites
Balsam-fir	Y.T., Alta., Sask., Man., Ont., Que., N.B., N.S., P.E.I., Nfld.	Wide range of moist, rich soils; drought resistant	Vegetation buffer; wildlife food, shelter, and nesting sites
Cedar	Coast to coast	Alongside stream banks and lake shores; wet sites alongside wetlands	Food and cover for marsh birds, songbirds, and mammals
Paper-birch	Coast to coast	Full sun to partial shade; wide range of moist soils	Erosion control; vegetation buffer; wildlife food and cover
Red maple	Man., Ont., Que., N.B., N.S., P.E.I., Nfld.	Wide range of shoreline soils; flood tolerant	Erosion control; vegetation buffer; wildlife food and cover
Shining Willow	Sask., Man., Ont., Que., N.B., P.E.I., N.S., Nfld.	Moist to wet conditions	Erosion control; vegetation buffer; wildlife cover
Spruce	Coast to coast	Wet sites alongside lakes, streams, and wetlands	Vegetation buffer; wildlife food, cover, and nesting sites
Tamarack	Y.T., N.W.T., Ont., Que., N.B., N.S., P.E.I., Nfld.	Alongside stream banks and lake shores; wet sites alongside wetlands	Vegetation buffer; food and cover for shoreline birds and mammals
Trembling aspen	Man., Ont., Que., N.B., N.S., P.E.I., Nfld.	Full sun to partial shade; wide range of shoreline soils	Erosion control; vegetation buffer; food and cover for shoreline birds and mammals

White pine	Y.T., N.W.T., B.C., Alta., Sask., Man., Ont., Que., N.B., N.S., P.E.I., Nfld.	Wide range of soils; dry sites alongside wetlands	Food and cover for shoreline birds and mammals
Yellow birch	Ont., Que., N.B., N.S. P.E.I., Nfld.	Full sun to partial shade; moist shoreline soils	Erosion control; vegetation buffer; wildlife food and cover
Grasses			
Clovers	Coast to coast	Full sun; wet soils bordering on streams, lakes, and wetlands	Food and cover for upland birds and mammals; nectar source for pollinating insects
Rough fescue	Y.T., N.W.T., B.C., Alta., Sask., Man., Ont., Que., Nfld.	Full sun; dry to moist soils bordering on streams, lakes, and wetlands	Erosion control; vegetation buffer; food and cover for upland birds, mammals, and insects

APPENDIX 8

Bird-watching (Viewing) Tower

Viewing Tower in Hankasalmi, Finland. Photo: Wikipedia



APPENDIX 9

Bird Blinds

Enclosed Bird Blind in Winterland. Photo by: Charmaine Barney



**Bird Blind in Grand Falls – Windsor.
Photo Courtesy: Corduroy Brook Enhancement Association**



APPENDIX 10

Viewing Deck

Image of viewing deck in Winterland. Photo by: Charmaine Barney



APPENDIX 11

Appropriate wording required for a potential “No-shooting” sign



**THE DISCHARGE OF A FIREARM
WITHIN 1,000 METRES OF A SCHOOL,
PLAYGROUND OR ATHLETIC FIELD,
OR WITHIN 300 METRES OF A DWELLING
IS NOT PERMITTED.**

**NEWFOUNDLAND AND LABRADOR WILD LIFE ACT
WILD LIFE REGULATION 111 (1)**